



SCHOOL of  
GRADUATE STUDIES  
EAST TENNESSEE STATE UNIVERSITY

East Tennessee State University  
**Digital Commons @ East  
Tennessee State University**

---

Electronic Theses and Dissertations

Student Works

---

12-2015

# On Properties of $r_W$ -Regular Graphs

Franklina Samani

*East Tennessee State University*

Follow this and additional works at: <https://dc.etsu.edu/etd>



Part of the [Mathematics Commons](#)

---

## Recommended Citation

Samani, Franklina, "On Properties of  $r_W$ -Regular Graphs" (2015). *Electronic Theses and Dissertations*. Paper 2601. <https://dc.etsu.edu/etd/2601>

This Thesis - Open Access is brought to you for free and open access by the Student Works at Digital Commons @ East Tennessee State University. It has been accepted for inclusion in Electronic Theses and Dissertations by an authorized administrator of Digital Commons @ East Tennessee State University. For more information, please contact [digilib@etsu.edu](mailto:digilib@etsu.edu).

On Properties of  $r_w$ -Regular Graphs

---

A thesis

presented to

the faculty of the Department of Mathematics

East Tennessee State University

In partial fulfillment

of the requirements for the degree

Master of Science in Mathematical Sciences

---

by

Franklina Samani

December 2015

---

Debra Knisley, Ph.D., Chair

Teresa Haynes, Ph.D.

Robert Gardner, Ph.D.

Keywords: graph theory, weighted graph,  $a_w$  - *regular* graph.

## ABSTRACT

### On Properties of $r_w$ -Regular Graphs

by

Franklina Samani

If every vertex in a graph  $G$  has the same degree, then the graph is called a regular graph. That is, if  $\deg(v) = r$  for all vertices in the graph, then it is denoted as an  $r$ -regular graph. A graph  $G$  is said to be vertex-weighted if all of the vertices are assigned weights. A generalized definition for degree regularity for vertex-weighted graphs can be stated as follows: A vertex-weighted graph is said to be  $r_w$ -regular if the sum of the weights in the neighborhood of every vertex is  $r_w$ . If all vertices are assigned the unit weight of 1, then this is equivalent to the definition for  $r$ -regular graphs. In this thesis, we determine if a graph has a weighting scheme that makes it a weighted regular graph or prove no such scheme exists for a number of special classes of graphs such as paths, stars, caterpillars, spiders and wheels.

Copyright by Franklina Samani 2015

## DEDICATION

With love I dedicate this dissertation to the three most important people in my life.

Mr. Donald Samani

Miss Lucy Dabuo

Mr. Seth Bomangsaan Eledi.

## ACKNOWLEDGMENTS

First and foremost I would like to praise and thank God, the Almighty, whose many blessings and favor have brought me this far and made me who I am today. His gift of wisdom, knowledge, understanding and good health enabled me to begin and complete this piece of work. I am eternally grateful for His guidance and protection, enabling me to overcome all the trials with determination and perseverance to make this study possible.

I would like to express my sincere gratitude to my thesis advisor Dr. Debra Knisley for her guidance and encouragement through the learning process of this masters thesis. Her support and inspiring suggestions have been precious to the development of this work. Furthermore, I am grateful to Dr. Teresa Haynes for introducing me to graph theory proofs and teaching me how to do research. Working with her equipped me with the necessary tools needed for this research. I am also forever grateful and deeply indebted to Dr. Robert Gardner for giving me the opportunity to start this program and making my graduate school dream at ETSU a reality. Without him this would not have been possible. Special thanks goes to Dr. Robert Beeler for introducing me to graph theory. He has contributed immensely to my interest in graph theory.

My greatest gratitude goes to my parents Mr. & Mrs. Samani, for their love, prayers and sacrifices towards my education. I am extremely grateful to my siblings Destina, Dedican, Hartin and Freeman for their prayers, invaluable support and encouragement to pursue this study. To my sweetheart Seth B. Eledi, who has always been there for me and showed unconditional love, support and encouragement during

my program, I would like to say thank you for all you do for me. I owe a debt of gratitude to the Eledi family, Benedict E. Adjogah, Kwadwo Antwi-Fordjour and Mr. Patrick Ofosuhene for their support, advice and encouragement. Your contribution and support for the success of this work is greatly appreciated.

Last but not least, my profound gratitude goes to all those within the university and beyond who have contributed in diverse ways towards the completion of this work and whose names I have not mentioned.

GOD BLESS YOU ALL.

## CONTENTS

ABSTRACT . . . . .	2
DEDICATION . . . . .	4
ACKNOWLEDGMENTS . . . . .	6
LIST OF FIGURES . . . . .	9
1 INTRODUCTION . . . . .	10
1.1 Background . . . . .	15
2 RESULTS ON TREES . . . . .	16
3 OTHER FAMILIES OF GRAPHS . . . . .	31
4 CONCLUSION . . . . .	44
BIBLIOGRAPHY . . . . .	45
VITA . . . . .	49



## LIST OF FIGURES

1	House graph . . . . .	10
2	An $8_w$ -regular House graph . . . . .	11
3	A graph which is not weighted-regular . . . . .	12
4	An example of an $a_w$ - <i>regular</i> graph . . . . .	13
5	Path of length 4 ( $P_4$ ) . . . . .	14
6	A Tree with $d(u, v) = 4$ . . . . .	16
7	Example of a Caterpillar with $k = 4$ . . . . .	17
8	Example of a Lobster graph . . . . .	18
9	A $5_w$ -regular $P_6$ . . . . .	20
10	A $3_w$ -regular $P_7$ . . . . .	21
11	A $6_w$ -regular $P_8$ . . . . .	22
12	A $21_w$ -regular star graph ( $S_9$ ) . . . . .	23
13	Example of Weighted Regular Double Star of order 12 . . . . .	23
14	A $4_w$ - <i>regular</i> $G_2$ graph . . . . .	25
15	A $3_w$ - <i>regular</i> $G_2$ graph . . . . .	26
16	A $5_w$ - <i>regular</i> $G_2$ graph . . . . .	28
17	A $4_w$ - <i>regular</i> $G_2$ graph . . . . .	29
18	A $3_w$ - <i>regular</i> $G_2$ graph . . . . .	30
19	A Fan graph on 4 vertices ( $F_4$ ) . . . . .	33
20	A $14_w$ -regular Fan Graph . . . . .	34
21	A Fan graph on 5 vertices ( $F_5$ ) . . . . .	35
22	A $6_w$ -regular Fan Graph . . . . .	36

23	A Fan graph on 6 vertices ( $F_6$ ) . . . . .	37
24	A Fan graph on 7 vertices ( $F_7$ ) . . . . .	38
25	A $8_w$ -regular Fan Graph . . . . .	40
26	A $12_w$ -regular Wheel Graph ( $W_{4+1}$ ) . . . . .	42
27	A $17_w$ -regular Bipartite Graph . . . . .	43

## 1 INTRODUCTION

In this thesis we study a mathematical construction known as a graph. A graph  $G$  consists of a finite set of vertices  $V(G)$  called the vertex set, an edge set  $E(G)$ , and a relation that associates one edge with two vertices called the endpoints of the edge. Figure 1 is an example of a graph with 5 vertices and 6 edges.

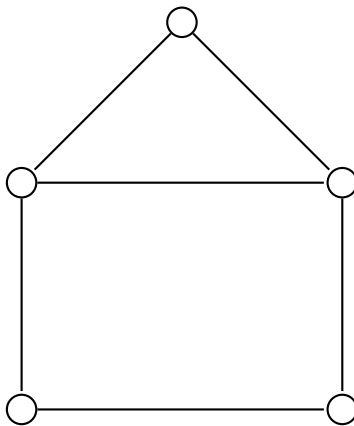

Figure 1: House graph

For the purposes of this thesis, we will assume that all graphs presented are simple, i.e. no loops (edges whose endpoints are equal), no multiple edges (more than one edge that has the same endpoints) [27]. An edge  $uv$  in  $G$  implies  $u$  is adjacent to  $v$  and the edge  $uv$  is said to be incident to the vertices  $u$  and  $v$  ( $u$  and  $v$  are the endpoints of the edge  $uv$ ). The set of all vertices adjacent to  $u$  is called the neighborhood of  $u$ . If every vertex in the graph has the same degree, then the graph is called a regular graph. That is, if  $deg(v) = r$  for all vertices in the graph, then the graph is denoted as an  $r$ -regular graph. A large volume of work has been done in relation to regular graphs, some of which include [1, 7, 12, 15, 16, 25].

A graph  $G$  is said to be weighted if all of the vertices are assigned non negative integers called weights. In this thesis, we define what we call a weighted-regular graph. First, we generalize the definition of the degree of a vertex in a vertex-weighted graph as follows: the weighted degree of a vertex  $v$  is the sum of the weights of its neighbors and is denoted by  $deg_w(v) = \sum_{u \in N(v)} w(u)$  where  $w(u)$  is the assigned weight of  $u$  in  $G$ . If every vertex in the graph has the same weighted degree, then the graph is called a weighted-regular graph. That is, if  $deg_w(v) = a$  for all vertices in the graph, then it is denoted as an  $a_w$ -regular graph. Necessarily, all regular graphs can be considered weighted-regular graphs if each vertex has an understood weight of 1. In this thesis, we determine if a graph has a weighting scheme that makes it a weighted regular graph or prove no such scheme exists for a number of special classes of graphs.

For example, consider the graph in Figure 1. The graph in Figure 1 is not a regular graph since some of the vertices have degree 2 and some have degree 3. However, the vertex weighted graph in Figure 2 is a  $8_w$ -regular graph.

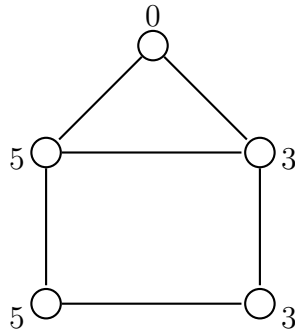

Figure 2: An  $8_w$ -regular House graph

Not all graphs allow a weighting scheme that produces an  $a_w$ -regular graph. For

instance, the graph in Figure 3 does not allow a weighting scheme that produces an  $a_w$ -regular graph.

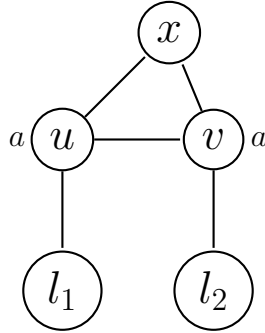

Figure 3: A graph which is not weighted-regular

Observe that the two support vertices  $u$  and  $v$  are assigned weights  $a$  each, for otherwise  $deg_w(l_1) \neq a$  and  $deg_w(l_2) \neq a$ . However since  $deg_w(x) = w(u) + w(v)$ , it implies  $deg_w(x) = a + a = 2a$  and since  $a = deg_w(l_1) = deg_w(l_2) \neq deg_w(x) = 2a$ , the graph does not allow a weighting scheme which makes it weighted-regular.

To determine if an arbitrary graph allows a weighting scheme is beyond the scope of this thesis. In this thesis, we determine if a vertex weighting scheme that results in a weighted regular graph exists for selected families of graphs. For example, the graph in Figure 4 is a tree that is weighted regular.

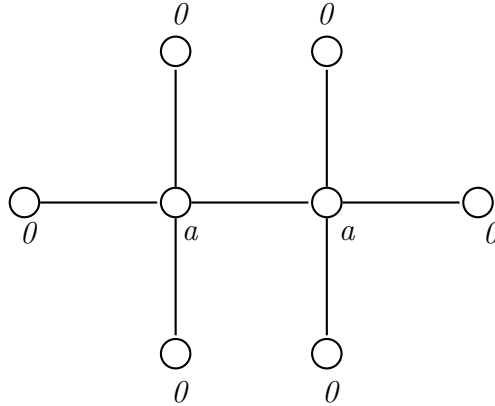

Figure 4: An example of an  $a_w$  - regular graph

Observe that the support vertices are assigned a weight of  $a$ , thus resulting in  $deg_w(v) = a$  for all  $v \in V$ . This implies that there exist a non trivial weighting scheme which makes the graph weighted regular.

In order to continue our discussion, we now define the necessary terms that we use to prove our results on selected families of graphs.

A *leaf* vertex is a vertex which has a degree of one and a *support* vertex is defined as a vertex with a leaf in its neighborhood. A *path* in  $G$  is a walk in which no vertex is repeated. A graph  $G$  is said to be *connected* if for all  $u, v \in V(G)$ , there is a  $uv$  path. Particularly, a path on  $n$  vertices is denoted as  $P_n$ . A path  $P_n$  is therefore a graph of order  $n$  and size  $n - 1$  with vertices denoted as  $v_1, v_2, v_3, \dots, v_n$  and edges  $v_i v_{i+1}$  for  $i = 1, 2, 3, \dots, n - 1$ .

The *length* of a path with endpoints  $u$  and  $v$  is the number of edges between  $u$  and  $v$  on a particular path from  $u$  to  $v$ . Figure 5 is an example of a graph of length 4. Thus, a path  $P_n$  has length  $n - 1$ .

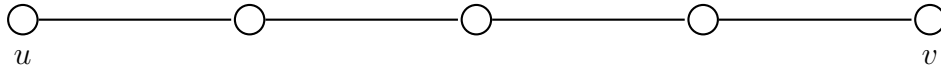

Figure 5: Path of length 4 ( $P_4$ )

A *cycle* is a  $u - v$  path with  $u = v$ . A cycle on  $n$  vertices is denoted as  $C_n$ . A *tree* denoted as  $T$  is an acyclic connected graph, i.e. it has no cycles [10]. A *caterpillar tree* as defined by Gordon and Breach [21] is a tree with the property that the removal of its leaves (vertices of degree one) results in a path. The caterpillar is made up of two types of vertices, namely the leaves (vertices of degree one) and vertices which are in the neighborhood of the leaves which we will refer to as support vertices.

A *star graph*,  $S_i$  (with  $i$  being the order of the graph) is an acyclic graph in which one vertex has degree  $i - 1$  and the rest have degree 1. A *double star* graph as defined in [11] is a graph consisting of the union of two stars  $S_{1,m}$  and  $S_{1,m}$  together with an edge joining their centers. A *spider* graph is a tree with at most one vertex of degree greater than one called the center. A *lobster* is a tree with the property that the removal of its leaves produces a caterpillar [5]. A *wheel graph*  $W_n$  is a graph of order  $n$  formed by connecting a vertex (sometimes called the central vertex) of degree  $n - 1$  to every vertex on a cycle of length  $n - 1$ . A *fan graph* is a graph formed by connecting a vertex  $v$  to all vertices on a path  $P_n$ . A *complete bipartite* graph  $K_{m,n}$  is a bipartite graph with every vertex in one partite set connected to every vertex in the other partite set, and no two vertices in the same partite set are connected.

## 1.1 Background

Graph theory is the study of properties of graphs in several fields such as mathematics and computer science. Several problems of interest in the world today can be represented by graphs. In the year 1736, a Swiss mathematician Leonhard Euler (1707 - 1783) solved the famous Königsberg bridge and that was the birth of graph theory.

A lot of research has been done on edge weighted graphs, however very little research has been done on vertex weighted graphs and hence this has become a growing area of research in graph theory. There are examples such as [19] where vertex weights are studied. However, a thorough literature search did not reveal any work resembling weighted-regular graphs.

Graceful labeling is one of the areas of graph theory where vertices are assigned a numerical values known as vertex weight. Many researchers such as Brankovic [8] and Edwards [9] have done a lot of work on graceful graphs. Several other researchers such as [2, 3, 4, 6, 13, 14, 17, 18, 20, 22, 23, 24, 26, 28] have also done some work where numerical values are assigned to vertices.

In this thesis, we determine if a vertex weighting scheme that results in a weighted regular graph exists for selected families of graphs. In particular, we determine if selected trees such as paths, caterpillars and spiders have a weighting scheme which make them weighted-regular. We also answer this question with respect to cycles, complete bipartite graphs, wheels and fans.



## 2 RESULTS ON TREES

We will start by proving a very useful proposition that we use in determining whether or not a tree is weighted-regular.

**Proposition 2.1** *If a graph  $G$  contains two vertices of degree 1,  $u$  and  $v$ , such that the distance  $d(u, v) = 4$ , then the graph does not have a nontrivial weighting scheme which makes it weighted regular.*

**Proof** Assume the graph  $G$  is an  $a_w$ -regular graph. We need to show that there exists a vertex  $x$  in the graph where  $deg_w(x) \neq a$ . Let  $u$  and  $v$  be vertices that are leaves such that  $d(u, v) = 4$ . Let  $s, y, z$  be the vertices between  $u$  and  $v$  as shown in Figure 6.

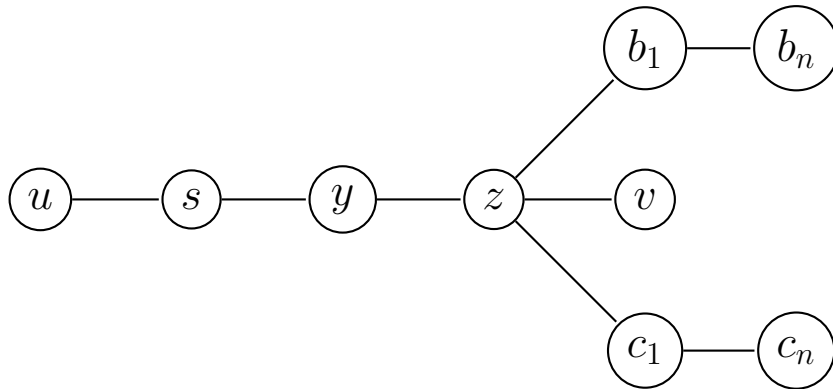

Figure 6: A Tree with  $d(u, v) = 4$

Then since  $u$  and  $v$  are leaves, they have just one neighbor each. Let  $a$  be the weight assigned to all the support vertices, then since  $s$  and  $z$  are support vertices; they will each be assigned a weight of  $a$ . Now as shown in Figure 6: vertex  $y$  has at

least two neighbors,  $s$  and  $z$ , that are support vertices. So the degree weight of  $y$  will be the sum of the assigned weights of its neighbors which include the assigned weights of  $s$  and  $z$ . This implies the degree weight of  $y$  is at least twice the weight of a support vertex. Thus,  $deg_w(y) \geq w(s) + w(z)$  and since since  $a \neq 0$ , then  $deg_w(y) \geq a + a$ . So,  $deg_w(y) \geq 2a > a$ .

This is a contradiction since  $a = deg_w(u) = deg_w(v) \neq deg_w(y) = 2a$ .

□

Proposition 2.1 is very useful in the determination of the weighted regularity of several other graphs such as a caterpillar and a lobster. Below are examples where Proposition 2.1 are used.

**Example 2.2** Let  $G_9$  be a caterpillar with 9 vertices (Refer to Figure 7). Let the support vertices  $(v_1, v_2, v_3, v_4)$  have weights 3 each. Thus,  $w(v_i) = 3$  for  $i = 1, 2, 3, 4$ . This implies that  $deg_w(v_i) = 3$  for  $i = 5, 6, 7, 8, 9$  (the leaves). So for the graph to be weighted regular, the degree weight of each vertex must be the same. Thus  $deg_w(v)$  has to be equal to 3 for all  $v \in V$ .

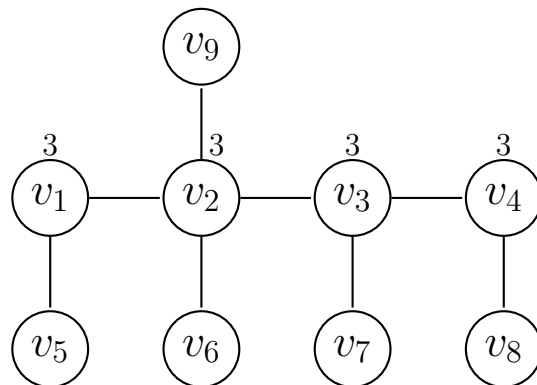

Figure 7: Example of a Caterpillar with  $k = 4$

Observe that there are two leaves, say  $v_5$  and  $v_7$ , such that  $d(v_5, v_7) = 4$ . Then clearly by Proposition 2.1 this graph does not have a weighting scheme which makes it weighted regular. This is because  $\deg_w(v_2) \geq w(v_1) + w(v_3) = 3 + 3 = 6 \neq \deg_w(v_5) = 3$ .

**Example 2.3** Let  $L$  be a lobster with two legs of length two, each connected to a vertex  $v_2$  on the central path  $(v_1, v_2, v_3, v_4)$  (Refer to Figure 8). Let the support vertices  $(v_5, v_6, v_3, v_7, v_8)$  have weights 5 each. Thus,  $w(v_i) = 5$  for  $i = 3, 5, 6, 7, 8$ . This implies that  $\deg_w(v_i) = 5$  for  $i = 9, 10, 11, 12, 13$  (the leaves). So for the graph to be weighted regular, the degree weight of each vertex must be the same. Thus  $\deg_w(v)$  has to be equal to 5 for all  $v \in V$ .

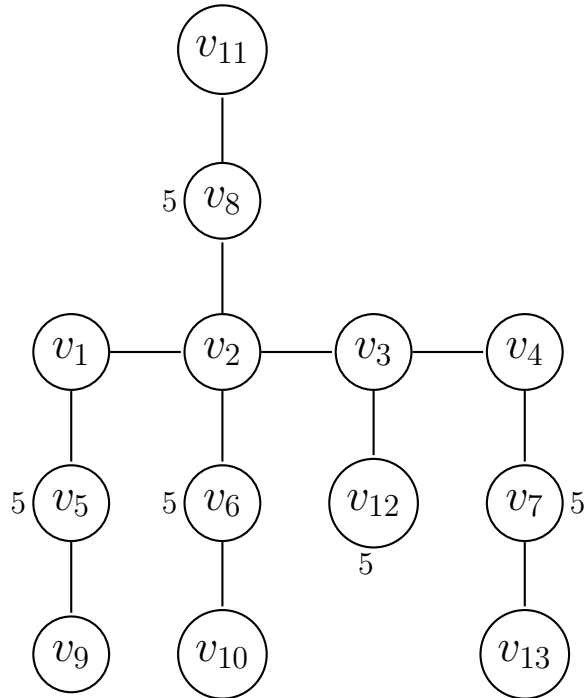

Figure 8: Example of a Lobster graph

Observe that there are two leaves, say  $v_6$  and  $v_8$ , such  $d(v_6, v_8) = 4$ . Then clearly by Proposition 2.1 this graph does not have a weighting scheme which makes it weighted regular. This is because  $\deg_w(v_2) \geq w(v_6) + w(v_3) + w(v_8) = 5 + 5 + 5 = 15 \neq \deg_w(v_9) = 5$ .

Several other graphs with  $d(x, y) = 4$  are also known not to have a nontrivial weighting scheme which makes it weighted regular as a result of Proposition 2.1.

**Theorem 2.4** *For a path of order  $n$  greater than 1, there exists a weighting scheme that makes the path  $a_w$ -regular except for paths of order  $n \equiv 1 \pmod{4}$ .*

**Proof** Let  $P_n$  be a path on  $n$  vertices. Let  $v_1, v_2, v_3, \dots, v_n$  be the vertices on the path. Then  $w(v_2) = w(v_{n-1}) = a$  since  $v_2$  and  $v_{n-1}$  are support vertices. This implies that  $\deg_w(v_1) = \deg_w(v_n) = a$ . So since  $w(v_2) = a$ , it implies that  $w(v_4) = 0$ , for otherwise  $\deg_w(v_3) \neq a$ . This implies that  $w(v_6) = a$ , for otherwise  $\deg_w(v_5) \neq a$ .  $\vdots$

So we have that;

$$w(v_i) = \begin{cases} a & \text{if } i \equiv 2 \pmod{4} \\ 0 & \text{if } i \equiv 0 \pmod{4} \end{cases}$$

**Case 1:** Paths of order  $n \equiv 1 \pmod{4}$ .

Since  $n \equiv 1 \pmod{4}$ , it implies that  $n - 1 \equiv 0 \pmod{4}$ . Therefore  $w(v_{n-1}) = 0$  and this contradicts the hypothesis that  $w(v_{n-1}) = a$ . Also  $w(v_{n-1})$  can not be 0 since that implies that  $\deg_w(v_n) = 0 \neq \deg_w(v_1) = a$ .

□

**Case 2:** Paths of order  $n \equiv 2 \pmod{4}$ .

Since  $n \equiv 2 \pmod{4}$ , it implies that  $w(n) = a$ . Also since  $w(v_{n-1}) = a$ , it implies that  $w(v_{n-3}) = 0$ , for otherwise  $\deg_w(v_{n-2}) \neq a$ . So since  $n \equiv 2 \pmod{4} \implies n - 1 \equiv 1 \pmod{4} \implies n - 2 \equiv 0 \pmod{4} \implies n - 3 \equiv 3 \pmod{4}$ . So we have:

$$w(v_i) = \begin{cases} a & \text{if } i \equiv 1 \pmod{4} \\ 0 & \text{if } i \equiv 3 \pmod{4} \end{cases}$$

Therefore  $\deg_w(v) = a$  for all  $v \in V$ .

□

**Example 2.5** Consider a path on 6 vertices ( $P_6$ ).

$$\text{Let } w(v_i) = \begin{cases} 5 & \text{if } i \equiv 2 \pmod{4} \\ 0 & \text{if } i \equiv 0 \pmod{4} \\ 5 & \text{if } i \equiv 1 \pmod{4} \\ 0 & \text{if } i \equiv 3 \pmod{4} \end{cases}$$

Then we have  $w(v_2) = w(v_6) = 5 = w(v_1) = w(v_5)$  and  $w(v_3) = w(v_4) = 0$ .

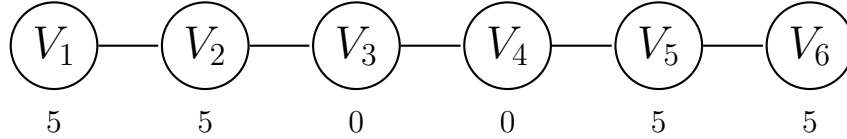

Figure 9: A  $5_w$ -regular  $P_6$

Therefore  $\deg_w(v) = 5$  for all  $v \in V$ . Hence the path is  $5_w$ -regular.

**Case 3:** Paths of order  $n \equiv 3 \pmod{4}$ .

Since  $n \equiv 3 \pmod{4}$ , it implies that  $n - 1 \equiv 2 \pmod{4}$ . Therefore  $w(v_{n-1}) = a$ . Now,  $w(v_1)$  can either be 0 or  $a$ . Without loss of generality let  $w(v_1) = a$ . This implies that  $w(v_3) = 0$ , for otherwise  $\deg_w(v_2) \neq a$ . So we have

$$w(v_i) = \begin{cases} a & \text{if } i \equiv 1 \pmod{4} \\ 0 & \text{if } i \equiv 3 \pmod{4} \end{cases}$$

Therefore  $\deg_w(v) = a$  for all  $v \in V$ .

□

**Example 2.6** Consider a path on 7 vertices ( $P_7$ ).

$$\text{Let } w(v_i) = \begin{cases} 3 & \text{if } i \equiv 2 \pmod{4} \\ 0 & \text{if } i \equiv 0 \pmod{4} \\ 3 & \text{if } i \equiv 1 \pmod{4} \\ 0 & \text{if } i \equiv 3 \pmod{4} \end{cases}$$

Then,  $w(v_2) = w(v_6) = 3 = w(v_1) = w(v_5)$  and  $w(v_4) = 0 = w(v_3) = w(v_7)$ .

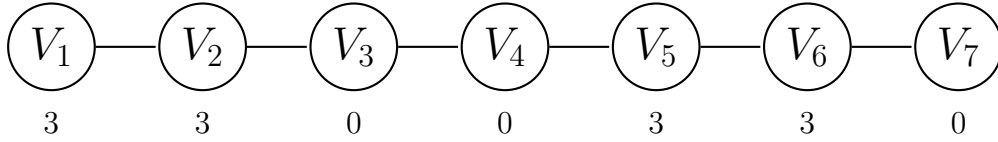

Figure 10: A  $3_w$ -regular  $P_7$

Therefore  $\deg_w(v) = 3$  for all  $v \in V$ . Hence the path is  $3_w$ -regular.

**Case 4:** Paths of order  $n \equiv 0 \pmod{4}$ .

Since  $n \equiv 0 \pmod{4}$ , it implies that  $w(n) = 0$ . Also since  $w(v_{n-1}) = a$ , it implies that  $w(v_{n-3}) = 0$ , for otherwise  $\deg_w(v_{n-2}) \neq a$ . So since  $n \equiv 0 \pmod{4} \implies n - 1 \equiv 3 \pmod{4} \implies n - 2 \equiv 2 \pmod{4} \implies n - 3 \equiv 1 \pmod{4}$ .

$$\text{So we have } w(v_i) = \begin{cases} a & \text{if } i \equiv 3 \pmod{4} \\ 0 & \text{if } i \equiv 1 \pmod{4} \end{cases}$$

Therefore  $\deg_w(v) = a$  for all  $v \in V$ .

□

**Example 2.7** Consider a path on 8 vertices ( $P_8$ ).

$$\text{Let } w(v_i) = \begin{cases} 6 & \text{if } i \equiv 2 \pmod{4} \\ 0 & \text{if } i \equiv 0 \pmod{4} \\ 6 & \text{if } i \equiv 3 \pmod{4} \\ 0 & \text{if } i \equiv 1 \pmod{4} \end{cases}$$

Then  $w(v_2) = w(v_6) = 6 = w(v_3) = w(v_7)$  and  $w(v_4) = w(v_8) = 0 = w(v_1) = w(v_5)$ .

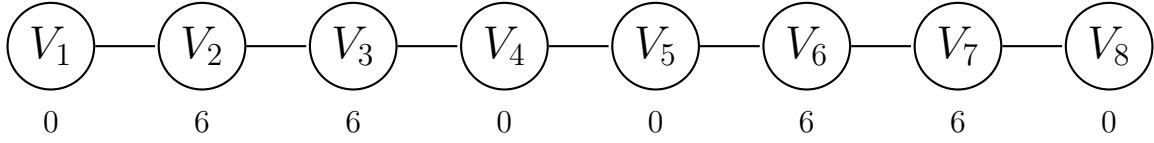

Figure 11: A  $6_w$ -regular  $P_8$

Therefore  $\deg_w(v) = 6$  for all  $v \in V$ . Hence the path is  $6_w$ -regular.

**Proposition 2.8** *Every star has a non trivial weighting scheme which makes it weighted regular and this is unique.*

**Proof** Let  $S_{n+1}$  be a star graph of order  $n + 1$ . Let  $v_{n+1}$  be the central vertex and  $v_i$  for  $i = 1, 2, \dots, n$  be the vertices of degree 1. So since  $v_{n+1}$  is adjacent to all the other vertices, its degree weight will be the sum of the weights of all the other vertices. Let  $\deg_w(v_{n+1}) = \sum_{i=1}^n w(v_i) = a$ . This implies that  $\sum_{i=1}^n w(v_i) = w(v_{n+1})$ , for otherwise  $\deg_w(v_i) \neq a$  for  $i = 1, 2, \dots, n$ . Therefore  $\deg_w(v_i) = a$  for all  $v \in V$ . Hence  $S_{n+1}$  is  $a_w$ -regular.

□

**Example 2.9** *Let  $S_9$  be a star graph of order 9. Then  $v_{n+1} = v_9$  for  $n = 8$ . Let  $w(v_1) = 2, w(v_2) = 3, w(v_3) = 0, w(v_4) = 2, w(v_5) = 8, w(v_6) = 1, w(v_7) = 4, w(v_8) = 1$ . Therefore  $\deg_w(v_9) = \sum_{i=1}^8 w(v_i) = 21$ . This implies that  $w(v_9) = 21$ . Therefore  $\deg_w(v_i) = 21$  for all  $v \in V$ . Hence the star graph  $S_9$  is  $21_w$ -regular (Refer to Figure 12).*

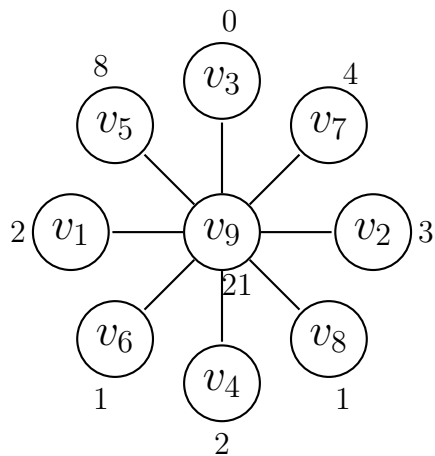

Figure 12: A  $21_w$ -regular star graph ( $S_9$ )

**Theorem 2.10** *Every double star has a non trivial weighting scheme which makes it weighted regular and this weighting scheme is unique.*

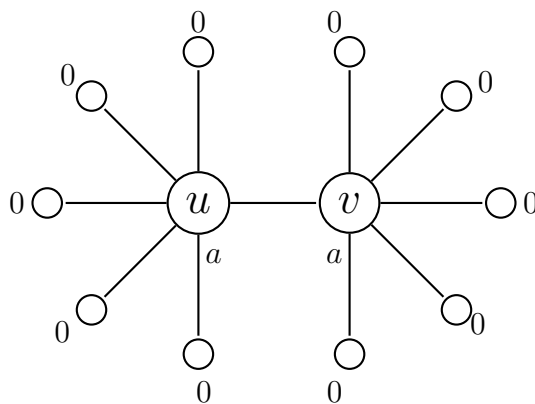

Figure 13: Example of Weighted Regular Double Star of order 12

**Proof** Let  $T$  be a double star of order  $n$ . Let  $u$  and  $v$  be the central vertices of the two stars that are connected by an edge. Notice that  $u$  and  $v$  are support vertices and



the only two vertices with degree greater than 1, thus the remaining  $n - 2$  vertices are leaves since they have degrees 1. Assign a weight of  $a$  to each of vertices  $u$  and  $v$  since they are support vertices. Also a weight of 0 is assigned to the remaining vertices (Refer to Figure 13). Observe that this nontrivial weighting scheme makes the double star weighted regular and hence we can conclude that there exist a weighting scheme which makes the double star weighted-regular.

□

We will now consider a particular type of spider with a fixed leg of length 2.

Let  $G_2$  be a spider with a fixed leg of length 2 and the number of remaining legs equal to  $k$ . We will call the central vertex  $x$  and the paths from  $x$ , the legs of the spider. Also, let  $l$  be a path of length 2 with  $u_1$  and  $u_2$  the leaf and support vertices respectively on paths  $l$ .

$p$  = number of paths of length  $\equiv 1 \pmod{4}$

$q$  = number of paths of length  $\equiv 2 \pmod{4}$

$s$  = number of paths of length  $\equiv 3 \pmod{4}$

$t$  = number of paths of length  $\equiv 0 \pmod{4}$

This implies that  $p + q + s + t = k$ .

**Proposition 2.11**  $G_2$  has a nontrivial weighting scheme which makes it weighted-regular if  $k = t$ , thus  $p = q = s = 0$ .

**Proof** Let  $w(u_2) = a$  where  $a \neq 0$ . This implies that  $deg_w(u_1) = a$ . Thus graph  $G_2$  must be  $a_w$ -regular. Let  $P = \{v_1, v_2, \dots, v_n\}$  be a path of length  $h$  where  $h \equiv 0 \pmod{4}$ . This implies that  $w(v_{h-1}) = a$  for all  $k$  legs. Note that this implies that  $w(v_{h-3}) = 0$ , for otherwise  $deg_w(v_{h-2}) \neq a$ . So we have:

$w(v_{h-1}) = a \implies w(v_{h-3}) = 0 \implies w(v_{h-5}) = a \implies \dots \implies w(v_1) = 0$ . Let  $u_2 = b$ . Then this implies  $w(x) = a - b$ , otherwise  $deg_w(u_2) = w(x) + w(u_1) \neq a$ . Notice that the weights of  $v_1, v_2, v_3, v_4$  are  $0, b, a, a - b$  respectively. Therefore since the  $deg_w(v) = a$  for all  $v \in V$ , graph  $G_2$  is  $a_w - regular$ .

□

*Example*

Let the weight  $a = 4$  and the weight  $b = 1$ .

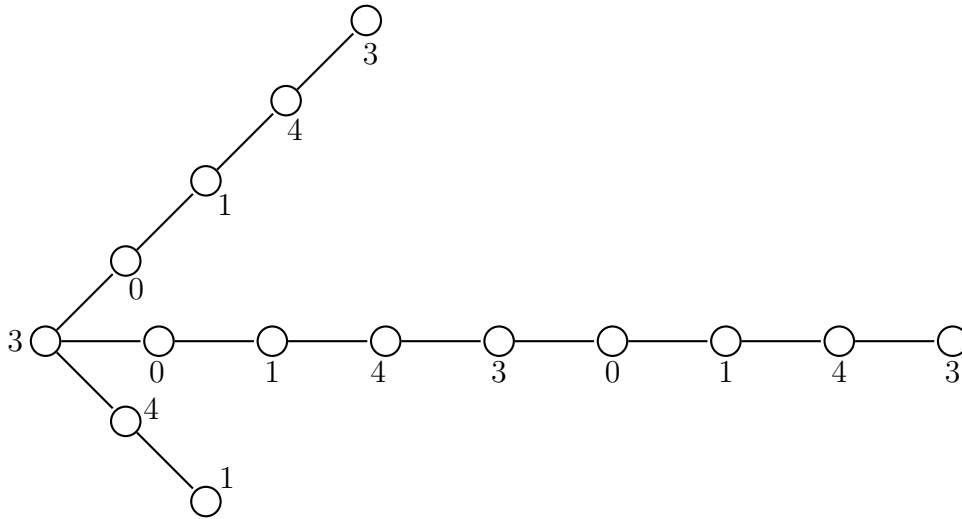

Figure 14: A  $4_w - regular$   $G_2$  graph

**Proposition 2.12**  $G_2$  has a nontrivial weighting scheme which makes it weighted-regular if  $k = p$ , thus  $q = s = t = 0$ .

**Proof** Let  $w(u_2) = a$  where  $a \neq 0$ . This implies that  $deg_w(u_1) = a$ . Thus graph  $G_2$  must be  $a_w - regular$ . Let  $P = \{v_1, v_2, \dots, v_n\}$  be a path of length  $h + 1$  where

$h + 1 \equiv 1 \pmod{4}$ . This implies that  $w(v_h) = a$  for all  $k$  legs. Note that this implies that  $w(v_{h-2}) = 0$ , for otherwise  $\deg_w(v_{h-1}) \neq a$ . So we have:

$w(v_h) = a \implies w(v_{h-2}) = 0 \implies w(v_{h-4}) = a \implies \dots \implies w(v_2) = 0$ . Then this implies  $w(x) = a$ , otherwise  $\deg_w(u_1) = w(x) + w(u_2) \neq a$ . And since  $w(x) = a \implies w(u_1) = 0$ , otherwise  $\deg_w(u_2) \neq a$ . Notice that the weights of  $v_1, v_2, v_3, v_4$  are  $a, b, b, a$  respectively, and this weighting pattern is repeated on all  $p$  legs. Therefore since the  $\deg_w(v) = a + b$  for  $b = 0$ . It implies that  $\deg_w(v) = a$  for all  $v \in V$ , so graph  $G_2$  is  $a_w$ -regular.

□

**Example 2.13** Let the weight  $a = 3$  and  $b = 0$ .

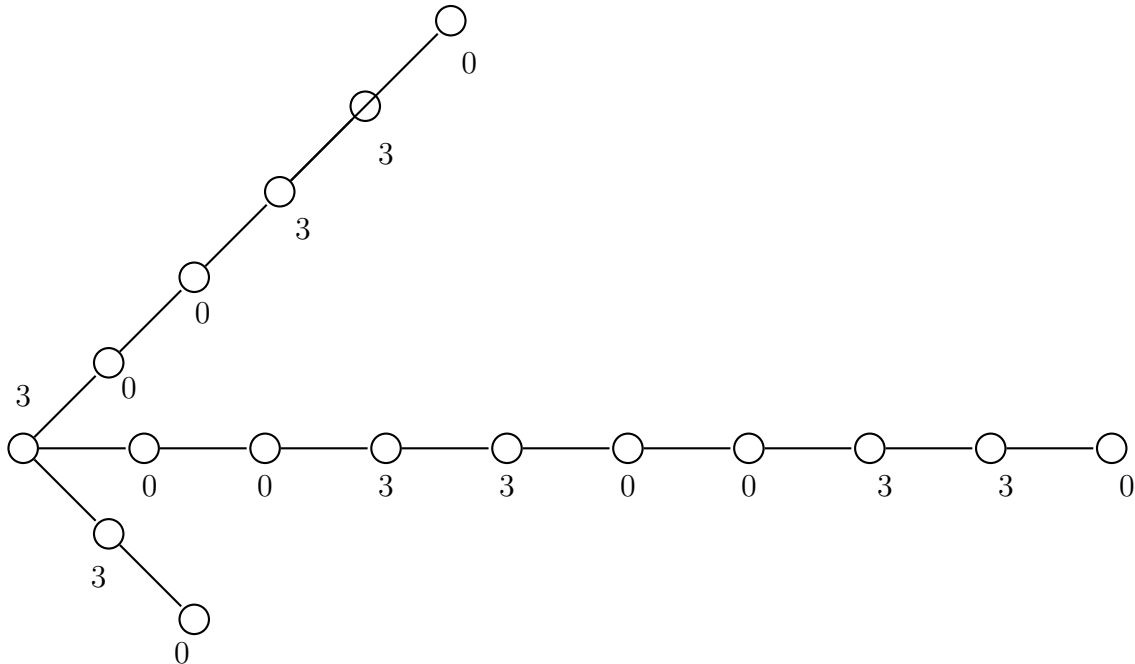

Figure 15: A  $3_w$ -regular  $G_2$  graph

**Proposition 2.14** *There does not exist a nontrivial weighting scheme that makes  $G_2$  regular if  $k = q$ , thus  $p = s = t = 0$ .*

**Proof** Let  $w(u_2) = a$  where  $a \neq 0$ . This implies that  $\deg_w(u_1) = a$ . Thus graph  $G_2$  must be  $a_w$ -regular. Let  $P = \{v_1, v_2, \dots, v_n\}$  be a path of length  $h + 2$  where  $h + 2 \equiv 2 \pmod{4}$ . This implies that  $w(v_{h+1}) = a$  for all  $k$  legs. Note that this implies that  $w(v_{h-1}) = 0$ , for otherwise  $\deg_w(v_h) \neq a$ . So we have:

$$w(v_{h+1}) = a \implies w(v_{h-1}) = 0 \implies w(v_{h-3}) = a \implies \dots \implies w(v_1) = a.$$

Now, since  $u_2$  and  $v_1$  are both neighbors of  $x$ , it implies that  $\deg_w(x) = w(u_2) + w(v_1) = a + a = 2a$ . So  $\deg_w(x) \neq a$  and thus a contradiction. Therefore graph  $G_2$  does not have a nontrivial weighting scheme which makes it weighted-regular when  $k = q$ .

□

**Proposition 2.15**  *$G_2$  has a nontrivial weighting scheme which makes it weighted-regular if  $k = s$ , thus  $p = q = t = 0$ .*

**Proof** Let  $w(u_2) = a$  where  $a \neq 0$ . This implies that  $\deg_w(u_1) = a$ . Thus graph  $G_2$  must be  $a_w$ -regular. Let  $P = \{v_1, v_2, \dots, v_n\}$  be a path of length  $h + 3$  where  $h + 3 \equiv 3 \pmod{4}$ . This implies that  $w(v_{h+2}) = a$  for all  $k$  legs. Note that this implies that  $w(v_h) = 0$ , for otherwise  $\deg_w(v_{h+1}) \neq a$ . So we have:

$$w(v_{h+2}) = a \implies w(v_h) = 0 \implies w(v_{h-2}) = a \implies \dots \implies w(v_2) = a.$$

Then this implies  $w(x) = 0$ , otherwise  $\deg_w(u_1) = w(x) + w(u_2) \neq a$  and  $\deg_w(v_1) = w(x) + w(v_2) \neq a$ . So since  $w(x) = 0$ , it implies that  $w(u_1) = a$ , otherwise  $\deg_w(u_2) \neq a$ . Notice that the weights of  $v_1, v_2, v_3, v_4$  are  $b, b, a, a$  respectively, and this weighting pattern is repeated on all  $s$  legs. Therefore since the  $\deg_w(v) = a + b$  for  $b = 0$ . It implies that  $\deg_w(v) = a$  for all  $v \in V$ , hence graph  $G_2$  is  $a_w$ -regular.

□

**Example 2.16** Let the weight  $a = 5$  and the weight  $b = 0$ .

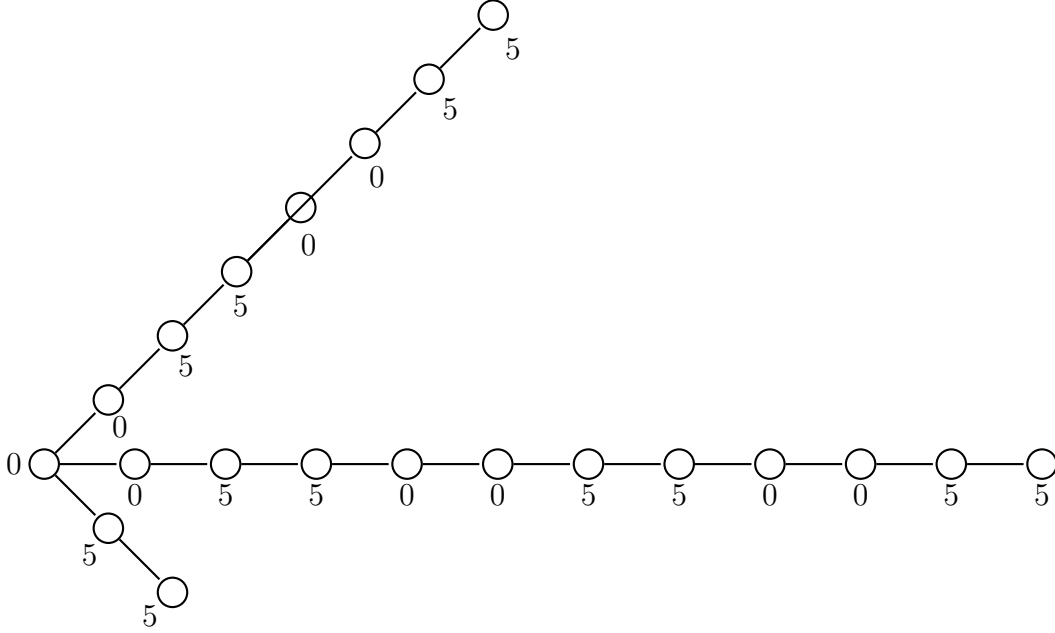

Figure 16: A  $5_w$  - regular  $G_2$  graph

**Proposition 2.17**  $G_2$  has a nontrivial weighting scheme which makes it weighted-regular if  $k = t + p$ , thus  $p = s = 0$ .

**Proof** We know from Proposition 2.12 that  $w(x) = a$  since  $G_2$  has legs of length  $1 \pmod{4}$  and we have  $p$  of such legs. So using the weight assignment pattern in Propositions 2.11 and 2.12 for legs  $t$  and  $p$  respectively where  $b = 0$ : we have  $\deg_w(v) = a$  for every  $v \in V$ , hence graph  $G_2$  has a nontrivial weighting scheme which makes it  $a_w$  - regular. Therefore since the  $\deg_w(v) = a + b$  for  $b = 0$ . It implies that  $\deg_w(v) = a$  for all  $v \in V$ , hence graph  $G_2$  is  $a_w$ -regular.

□

**Example 2.18** Let the weight  $a = 4$  and the weight  $b = 0$ .

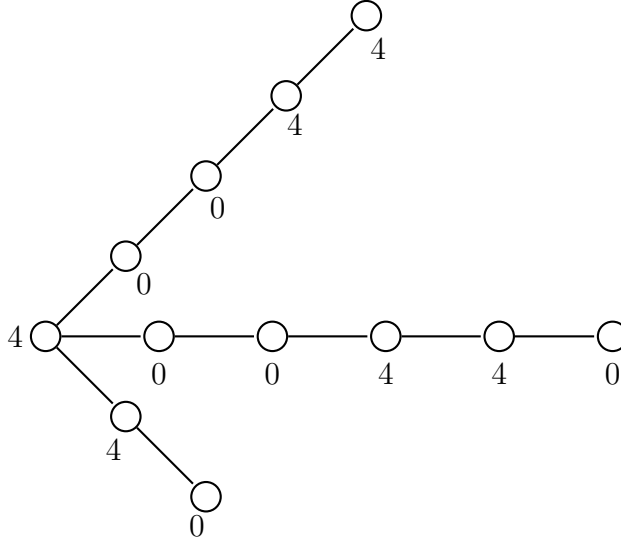

Figure 17: A  $4_w$  - regular  $G_2$  graph

**Proposition 2.19**  $G_2$  has a nontrivial weighting scheme which makes it weighted-regular if  $k = t + s$ , thus  $p = q = 0$ .

**Proof** We know from Proposition 2.14 that  $w(x) = 0$  since  $G_2$  has legs of length  $3 \pmod{4}$  and we have  $s$  of such legs. Let  $w(x) = 0 = b$ , then  $w(u_2) = a$  for otherwise  $\deg_w(u_1) \neq a$ . Also since  $w(x) = b$ , let  $w(u_1) = a - b$ , for otherwise  $\deg_w(u_2) = w(x) + w(u_1) \neq a$ . Notice that  $v_1, v_2, v_3, v_4$  have weights  $b, a - b, a, b$  where  $b = 0$ , on all  $k$  legs. Thus, this is the repeated weighting pattern on all  $k$  legs. Note that  $b = 0$ , for otherwise  $\deg_w(v_h + 3) \neq a$  since  $w(v_h + 2) = a - b$  for all  $s$  legs (legs of length  $\equiv 3 \pmod{4}$ ). Therefore  $\deg_w(v) = a$  for all  $v \in V$ , hence  $G_2$  has a nontrivial weighting scheme which makes it weighted regular when  $k = t + s$ .

□

**Example 2.20** Let the weight  $a = 4$  and the weight  $b = 0$ .

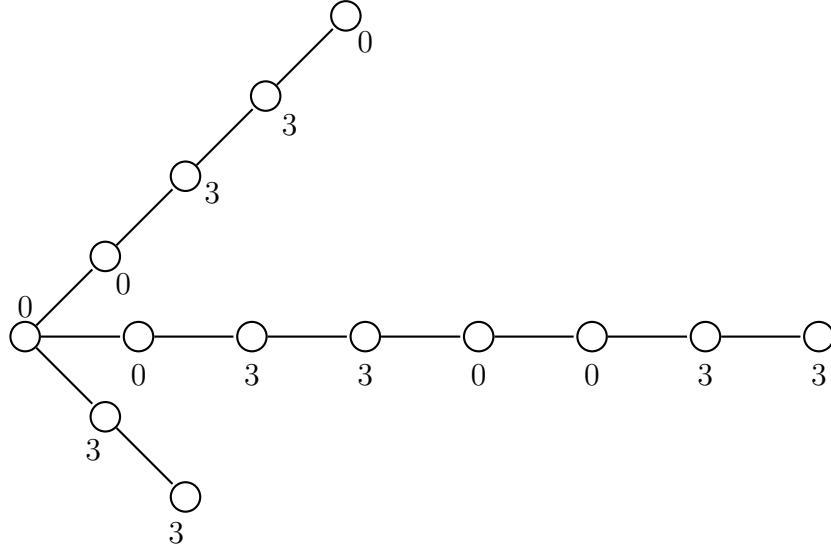

Figure 18: A  $3_w$ -regular  $G_2$  graph

**Proposition 2.21**  $G_2$  does not have a nontrivial weighting scheme which makes it weighted-regular if  $k = p + s$ , thus  $q = t = 0$ .

**Proof** By Proposition 2.12, we know that the presence of legs of length  $P \equiv 3 \pmod{4}$  in  $G_2$  implies that  $w(x) = 0$ , however by Proposition 2.12 we have that  $w(x) = a$  since  $G_2$  also has legs of length  $P \equiv 1 \pmod{4}$ . So since  $w(x)$  can not satisfy the weight requirements on both legs, there is a contradiction. Therefore we can conclude that there does not exist a nontrivial weighting scheme which makes  $G_2$  weighted-regular when  $k = p + s$ .

□

### 3 OTHER FAMILIES OF GRAPHS

In this chapter we are going to consider graphs other than trees. In particular, we will consider cycles, fan graphs, wheel graphs and bipartite graphs.

**Theorem 3.1** *Let  $C_n$  be a cycle on  $n$  vertices. Then  $C_n$  has a nontrivial weighting scheme which makes it weighted regular only if  $n \equiv 0 \pmod{4}$ .*

**Proof** Let  $C_n$  be a cycle with  $n$  vertices. Also let  $a, b, c$  be the assigned weights for  $v_1, v_2, v_3$  respectively. Then  $\deg_w(v_2) = w(v_1) + w(v_3) = a + c$ . So,

$$w(v_5) = a, \text{ for otherwise } \deg_w(v_4) \neq a + c.$$

$$w(v_7) = c, \text{ for otherwise } \deg_w(v_6) \neq a + c.$$

$\vdots$

$$\text{This implies that } w(v_i) = \begin{cases} a & \text{if } i \equiv 1 \pmod{4} \\ c & \text{if } i \equiv 3 \pmod{4} \end{cases}$$

**Case 1:** Consider  $n \equiv 1 \pmod{4}$ .

Since  $n \equiv 1 \pmod{4}$ , then  $w(v_n) = a$ . This implies that  $b = c$ , for otherwise  $\deg_w(v_1) \neq a + c$ . So  $w(v_2) = c$ , and this implies  $w(v_4) = a$  for otherwise  $\deg_w(v_3) \neq a + c$ . Also,  $w(v_6) = c$  for otherwise  $\deg_w(v_5) \neq a + c$ . So we have,

$$w(v_i) = \begin{cases} a & \text{if } i \equiv 0 \pmod{4} \\ c & \text{if } i \equiv 2 \pmod{4} \end{cases}$$

Now, since  $n \equiv 1 \pmod{4} \implies n-1 \equiv 0 \pmod{4} \implies n-2 \equiv 3 \pmod{4} \implies n-3 \equiv 2 \pmod{4}$ . Therefore  $w(v_{n-1}) = a$  since  $i = n-1 \equiv 0 \pmod{4}$ . This implies that  $\deg_w(v_n) = w(v_1) + w(v_{n-1}) = a + a = 2a \neq a + c$ . Hence  $C_n$  for  $n \equiv 1 \pmod{4}$  is not weighted regular.

□



**Case 2:** Consider  $n \equiv 2 \pmod{4}$ .

Since  $n \equiv 2 \pmod{4} \implies n - 1 \equiv 1 \pmod{4}$ . So,  $w(v_{n-1}) = a$ . Therefore  $deg_w(v_n) = w(v_1) + w(v_{n-1}) = a + a = 2a \neq a + c$ . Hence  $C_n$  for  $n \equiv 2 \pmod{4}$  is not weighted regular.

□

**Case 3:** Consider  $n \equiv 3 \pmod{4}$ .

Since  $n \equiv 3 \pmod{4} \implies w(v_n) = c$ . This implies that  $b = c$ , for otherwise  $deg_w(v_1) \neq a + c$ . Therefore  $w(v_2) = c$ . Then,

$$w(v_4) = c, \text{ for otherwise } deg_w(v_3) \neq a + c.$$

$$w(v_6) = a, \text{ for otherwise } deg_w(v_5) \neq a + c.$$

⋮

So we have that  $w(v_i) = \begin{cases} a & \text{if } i \equiv 2 \pmod{4} \\ c & \text{if } i \equiv 0 \pmod{4} \end{cases}$

Now, since  $n \equiv 3 \pmod{4} \implies n - 1 \equiv 2 \pmod{4} \implies n - 2 \equiv 1 \pmod{4} \implies n - 3 \equiv 0 \pmod{4}$ . So  $w(v_{n-1}) = a$  since  $i = n - 1 \equiv 2 \pmod{4}$  and therefore  $deg_w(v_n) = w(v_1) + w(v_{n-1}) = a + a = 2a \neq a + c$ . Hence  $C_n$  for  $n \equiv 3 \pmod{4}$  does not have a weighting scheme which makes it weighted regular.

□

**Case 4:** Consider  $n \equiv 0 \pmod{4}$ .

Since  $n \equiv 0 \pmod{4} \implies n - 1 \equiv 3 \pmod{4}$ , therefore  $w(v_{n-1}) = c \implies w(v_{n-3}) = a$ . The weight of  $v_4$  has to be either  $a$  or  $c$ , for otherwise  $deg_w(v_3) \neq a + c$ . Without loss of generality, let  $w(v_4) = c$ . This implies that  $w(v_2) = b = a$ . Also,

$w(v_6) = a$  for otherwise  $deg_w(v_5) \neq a + c$ .

$w(v_8) = c$ , for otherwise  $deg_w(v_7) \neq a + c$ .

$\vdots$

So we have  $w(v_i) = \begin{cases} a & \text{if } i \equiv 2 \pmod{4} \\ c & \text{if } i \equiv 0 \pmod{4} \end{cases}$

Therefore  $deg_w(v) = a + c$  for all  $v \in V$ , hence we can conclude that there exist a nontrivial weighting scheme which makes  $C_n$  for  $n \equiv 0 \pmod{4}$  weighted regular.

□

**Theorem 3.2** *Let  $F_4$  be a fan graph on 4 vertices. Then there exist a nontrivial weighting scheme which makes  $F_4$  weighting regular.*

**Proof** Let  $v_1, v_2, v_3, v_4$  be the 4 vertices with degrees 2, 3, 2, 3 respectively (Refer to Figure 19).

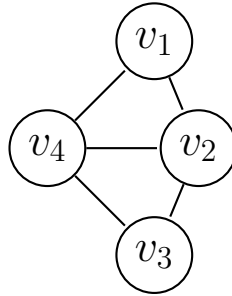

Figure 19: A Fan graph on 4 vertices ( $F_4$ )

Then,  $deg_w(v_4) = w(v_1) + w(v_2) + w(v_3)$  and  $deg_w(v_1) = w(v_2) + w(v_4)$ . Since  $deg_w(v_1) = deg_w(v_4)$ , it implies that  $w(v_4) = w(v_1) + w(v_3)$  (1).  $deg_w(v_2) = w(v_1) + w(v_3) + w(v_4)$ . So since  $deg_w(v_2) = deg_w(v_1)$ , it implies that  $w(v_2) = w(v_1) + w(v_3)$  (2). So from equations (1) and

(2), we have  $w(v_2) = w(v_4)$ .  $deg_w(v_3) = w(v_2) + w(v_4)$ . So since  $deg_w(v_3) = deg_w(v_2)$ , it implies that  $w(v_2) = w(v_1) + w(v_3)$ . Therefore,  $w(v_1) = w(v_2) - w(v_3)$ . So since  $deg_w(v) = 2w(v_4)$  for all  $v \in V$ , then there exist a nontrivial weighting scheme which makes  $F_4$  weighted regular.

□

**Example 3.3** Let  $w(v_2) = w(v_4) = 7$  and  $w(v_3) = 2$ , then  $w(v_1) = 7 - 2 = 5$ .

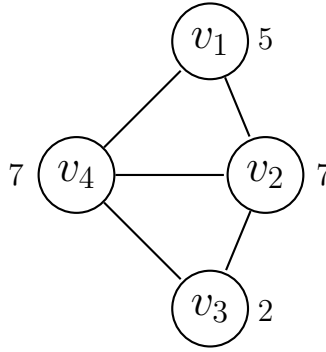

Figure 20: A  $14_w$ -regular Fan Graph

Clearly,  $deg_w(v) = 14$  for all  $v \in V$  hence the graph is a  $14_w$ -regular graph.

**Theorem 3.4** Let  $F_5$  be a fan graph on 5 vertices. Then there exists a nontrivial weighting scheme which makes  $F_5$  weighting regular.

**Proof** Let  $v_1, v_2, v_3, v_4, v_5$  be the 5 vertices with degrees 2, 3, 3, 2, 4 respectively (Refer to Figure 21).

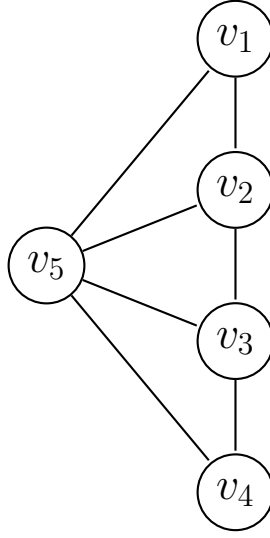

Figure 21: A Fan graph on 5 vertices ( $F_5$ )

The  $deg_w(v_5) = w(v_1) + w(v_2) + w(v_3) + w(v_4)$  and  $deg_w(v_1) = w(v_2) + w(v_5)$ .

Since  $deg_w(v_1) = deg_w(v_5)$ , it implies that,

$$w(v_5) = w(v_1) + w(v_3) + w(v_4) \quad (1). \quad deg_w(v_2) =$$

$w(v_1) + w(v_3) + w(v_5)$ . Since  $deg_w(v_2) = deg_w(v_5)$ , it implies that,

$$w(v_5) = w(v_2) + w(v_4) \quad (2). \quad \text{So from}$$

equations (1) and (2), we have  $w(v_2) = w(v_1) + w(v_3)$  (3).  $deg_w(v_4) =$

$w(v_3) + w(v_5)$ . Since  $deg_w(v_4) = deg_w(v_1)$ , it implies that,

$$w(v_2) = w(v_3) \quad (4). \quad \text{So from}$$

(3) and (4), we have  $w(v_1) = 0$ .  $deg_w(v_3) = w(v_2) + w(v_4) + w(v_5)$ . So since  $deg_w(v_3) =$

$deg_w(v_1)$ , it implies that  $w(v_4) = 0$ . So from equation (1) and the fact that  $w(v_1) =$

$0 = w(v_4)$ , we have  $w(v_5) = w(v_3)$  (5). So by

transitivity, we have  $w(v_2) = w(v_5)$  and this implies that  $w(v_2) = w(v_3) = w(v_5)$ .

Therefore since  $\deg_w(v) = 2w(v_2)$  for all  $v \in V$ , then there exist a nontrivial weighting scheme which makes  $F_5$  weighted regular.

□

**Example 3.5** Let  $w(v_2) = w(v_3) = w(v_5) = 3$  and  $w(v_1) = w(v_4) = 0$ .

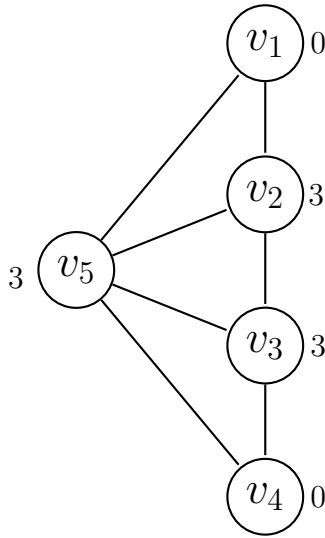

Figure 22: A  $6_w$ -regular Fan Graph

Clearly,  $\deg_w(v) = 6$  for all  $v \in V$  hence the graph is a  $6_w$ -regular graph.

**Theorem 3.6** Let  $F_6$  be a fan graph on 6 vertices. Then there does NOT exist a nontrivial weighting scheme which makes  $F_6$  weighting regular.

**Proof** Let  $v_1, v_2, v_3, v_4, v_5, v_6$  be the 6 vertices with degrees 2, 3, 3, 3, 2, 5 respectively (Refer to Figure 26). We need to show that the degree weights are equal for all the vertices in the graph.

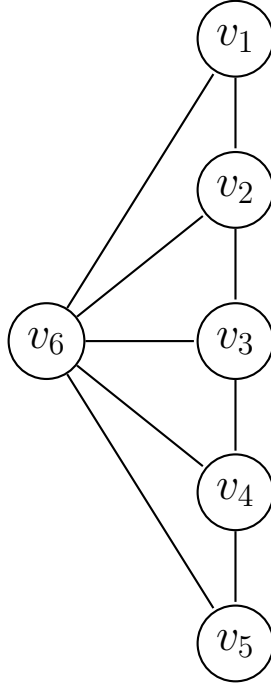

Figure 23: A Fan graph on 6 vertices ( $F_6$ )

We have  $deg_w(v_6) = w(v_1) + w(v_2) + w(v_3) + w(v_4) + w(v_5)$  and  $deg_w(v_1) = w(v_2) + w(v_6)$ . Since  $deg_w(v_1) = deg_w(v_6)$ , it implies that

$$w(v_6) = w(v_1) + w(v_3) + w(v_4) + w(v_5) \quad (1). \quad deg_w(v_2) = w(v_1) + w(v_3) + w(v_6).$$

Since  $deg_w(v_2) = deg_w(v_5)$ , it implies that,

$$w(v_6) = w(v_2) + w(v_4) + w(v_5) \quad (2).$$

So from equations (1) and (2), we have  $w(v_2) = w(v_1) + w(v_3)$  (3).  $deg_w(v_5) = w(v_4) + w(v_6)$ .

Since  $deg_w(v_5) = deg_w(v_1)$ , it implies that

$$w(v_4) = w(v_2) \quad (4).$$

So, since  $w(v_2) = w(v_4)$  from equations (2) and (4), we have  $w(v_6) = w(v_5)$ .  $deg_w(v_4) = w(v_3) + w(v_5) + w(v_6)$ . However since  $deg_w(v_4) = deg_w(v_2)$ , it implies that  $w(v_5) = w(v_1)$ .

$deg_w(v_3) = w(v_2) + w(v_4) + w(v_6)$ . However since  $deg_w(v_3) = deg_w(v_5)$ , it implies  $w(v_2) = 0$ . Therefore  $w(v_4) = 0$  by equation (4) and hence  $w(v_3) = -w(v_1)$  by equation (3). Clearly,  $w(v_5) = deg_w(v_1) = deg_w(v_2) = deg_w(v_3) = deg_w(v_5) = deg_w(v_6) \neq deg_w(v_4) = 2w(v_5) + w(v_3)$ . Hence the graph  $F_6$  does not have a nontrivial weighting scheme which makes it weighted regular.

□

**Theorem 3.7** *Let  $F_7$  be a fan graph on 7 vertices. Then there exist a nontrivial weighting scheme which makes  $F_7$  weighting regular.*

**Proof** Let  $v_1, v_2, v_3, v_4, v_5, v_6, v_7$  be the 7 vertices with degrees 2, 3, 3, 3, 3, 2, 6 respectively (Refer to Figure 24).

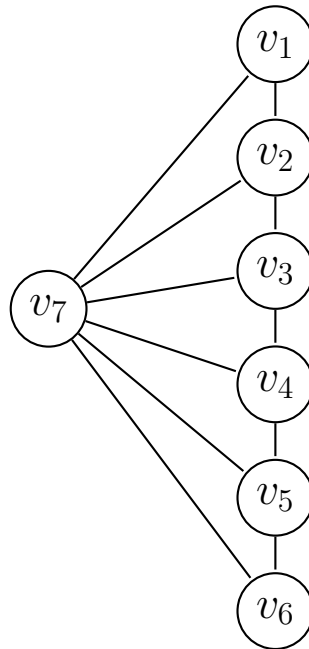

Figure 24: A Fan graph on 7 vertices ( $F_7$ )

$deg_w(v_7) = w(v_1) + w(v_2) + w(v_3) + w(v_4) + w(v_5) + w(v_6)$  and  $deg_w(v_1) = w(v_2) + w(v_7)$ . However since  $deg_w(v_1) = deg_w(v_7)$ , it implies that  $w(v_7) = w(v_1) + w(v_3) + w(v_4) + w(v_5) + w(v_6)$ .  $deg_w(v_2) = w(v_1) + w(v_3) + w(v_7)$ . So since  $deg_w(v_2) = deg_w(v_1)$ , it implies that,

$$w(v_2) = w(v_1) + w(v_3) \tag{1}. deg_w(v_3) =$$

$w(v_2) + w(v_4) + w(v_7)$ . So since  $deg_w(v_3) = deg_w(v_1)$ , it implies  $w(v_4) = 0$ .  $deg_w(v_6) = w(v_5) + w(v_7)$ . So since  $deg_w(v_6) = deg_w(v_1)$ , it implies  $w(v_5) = w(v_2)$ .  $deg_w(v_5) = w(v_4) + w(v_6) + w(v_7)$ . So since  $deg_w(v_5) = deg_w(v_6)$ , it implies  $w(v_5) = w(v_4) + w(v_6)$ . Therefore  $w(v_5) = w(v_6)$  since  $w(v_4) = 0$ .  $deg_w(v_4) = w(v_3) + w(v_5) + w(v_7)$ . So since  $deg_w(v_4) = deg_w(v_6)$ , it implies,

$$w(v_3) = 0 \tag{2}. So from$$

equations (1) and (2), we have  $w(v_1) = w(v_2)$ . This implies that  $w(v_1) = w(v_2) = w(v_5) = w(v_6)$ . Therefore without loss of generality,  $deg_w(v) = w(v_5) + w(v_6)$  for all  $v \in V$ . Hence there exist a nontrivial weighting scheme which makes  $F_7$  weighted regular.

□

**Example 3.8** *Let  $w(v_1) = w(v_2) = w(v_5) = w(v_6) = 2$  and  $w(v_3) = w(v_4) = 0$ . This implies that  $w(v_7) = 6$ .*



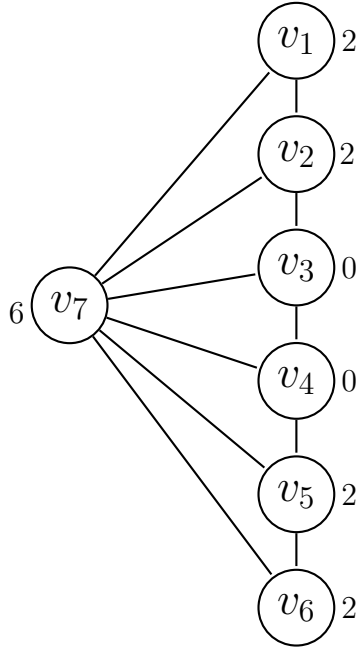

Figure 25: A  $8_w$ -regular Fan Graph

Clearly,  $\deg_w(v) = 8$  for all  $v \in V$  hence the graph is a  $8_w$ -regular graph.

OPEN CONJECTURE : A fan graph,  $F_n$ , has a nontrivial weighting scheme which makes it weighted regular when  $n \equiv 0, 1, 3 \pmod{4}$ , however for  $n \equiv 2 \pmod{4}$ ,  $F_n$  is not weighted regular.

**Theorem 3.9** *A wheel graph,  $W_{n+1}$ , for  $n \in \mathbb{N}$  has a nontrivial weighting scheme which makes them weighted regular.*

**Proof** Let  $W_{n+1}$  be a wheel graph with cardinality  $n + 1$  and  $v_{n+1}$  be the central vertex with degree  $n$ . This implies that there will be  $n$  vertices with degree 3 each. Assign the degree 3 vertices  $(v_1, v_2, v_3, v_4, \dots, v_n)$  weights  $a, b, a, b, \dots$ . This implies

that  $\deg_w(v_{n+1}) = ia + jb$  where  $i$  and  $j$  are the number of assigned weights  $a$  and  $b$  respectively.

Note that  $i + j = n$ . So we need to show that  $\deg_w(v) = ia + jb$  for all  $v \in V$ . Observe that  $\deg_w(v_2) = w(v_1) + w(v_3) + w(v_{n+1}) = a + a + w(v_{n+1})$ . However, since  $\deg_w(v_2)$  has to be equal to the  $\deg_w(v_{n+1})$ , we have  $a + a + w(v_{n+1}) = ia + jb$ .

This implies that,  $w(v_{n+1}) = (i - 2)a + jb$  (1). Therefore  $\deg_w(v_2) = ia + jb$ . Also,  $\deg_w(v_3) = w(v_2) + w(v_4) + w(v_{n+1}) = b + b + w(v_{n+1}) = 2b + w(v_{n+1})$ . However since  $\deg_w(v_3)$  has to be equal to  $\deg_w(v_{n+1}) = \deg_w(v_2)$ , we have  $2b + w(v_{n+1}) = ia + jb$ . This implies that

$$w(v_{n+1}) = ia + (j - 2)b \quad (2). \text{ So from}$$

equations (1) and (2), we have  $(i - 2)a + jb = ia + (j - 2)b$ . This implies  $a = b$ . Therefore without loss of generality,  $w(v_{n+1}) = (i - 2 + j)a = (i + j - 2)a = (n - 2)a$ . This implies  $\deg_w(v) = na = (i + j)a = ia + jb$  for all  $v \in V$  and thus  $W_{n+1}$  is weighted regular.

□

**Example 3.10** Let  $w(v_i) = 3$  for  $i=1,2,3,4$ . Then  $w(v_5) = (4 - 2)3 = 6$ .

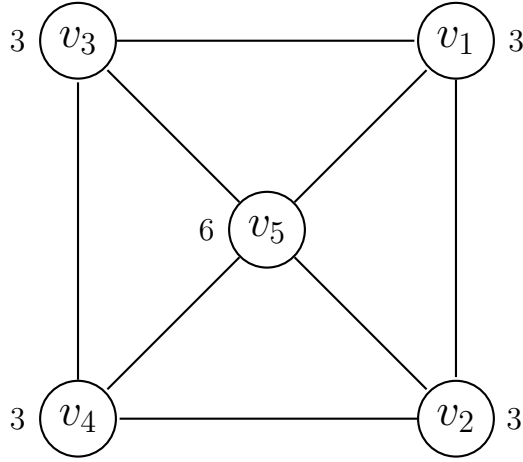

Figure 26: A  $12_w$ -regular Wheel Graph ( $W_{4+1}$ )

Clearly,  $\deg_w(v) = 12$  for all  $v \in V$  hence the graph is a  $12_w$ -regular graph.

**Theorem 3.11** *A complete bipartite graph  $K_{m,n}$  has a nontrivial weighting scheme which makes it weighted regular.*

**Proof** Let  $K_{m,n}$  be a complete bipartite graph with partite sets  $A$  and  $B$ . Then  $|A| = m$  and  $|B| = n$  and thus  $|V| = m + n$ . So for all  $v \in V$ ;  $\deg_w(v) = \sum w(v_i)$  for  $v_i \in B$  and  $i = 1, 2, \dots, n$ . Assign weights to  $u_i \in A$  for  $i = 1, 2, \dots, m$  such that  $\sum_{u \in A} w(u_i) = \sum_{v \in B} w(v_i)$ . Therefore clearly  $K_{m,n}$  is weighted regular.

□

Note that the above theorem is true for both equal( $m = n$ ) and unequal( $m \neq n$ ) partite sets.

**Example 3.12** *Let the weights of  $v_i \in B$  for  $i = 1, 2, 3, 4, 5$  be 7, 2, 5, 3, 0 respectively. Then the  $\deg_w(u_i) = 17$  for all  $u_i \in A$ . Also let the weights of  $u_i \in A$  for  $i = 1, 2, 3$  be 8, 2, 7 respectively.*

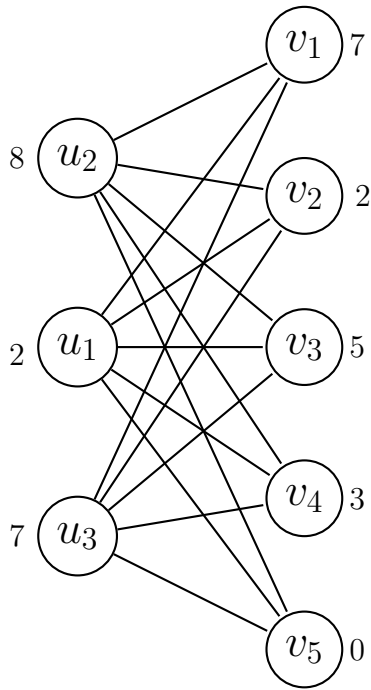

Figure 27: A  $17_w$ -regular Bipartite Graph

*Clearly,  $\deg_w(v) = 17$  for all  $v \in V$  hence the graph is a  $17_w$ -regular graph.*

## 4 CONCLUSION

is a large volume of work on regular graphs in the field of graph theory. On the other hand, a review of the literature did not reveal a substantial amount of work on vertex weighted graphs. Only a few topics such as graceful labellings employed vertex weights. In this thesis, we utilize vertex weights to generalized regularity of graphs. All regular graphs are trivially vertex weighted regular graphs, however, a graph that is not necessarily regular can be vertex weighted regular.

Vertex weighted graphs have numerous application in contemporary science. It is therefore important to know if there exist a weighting scheme that will make a graph a vertex weighted regular graph. We address this question for a number of families of graphs such as paths, stars, spider and the wheel graph.

A problem for further study will be to “weight-regularize” other families of graphs such as bipartite graphs, friendship graphs etc.

## BIBLIOGRAPHY

- [1] M. ABREU, G. ARAUJO-PARDO, C. BALBUENA, D. LABBATE, AND J. SALAS, *Small regular graphs of girth 7*, The Electronic Journal of Combinatorics, 22 (2015), pp. 3–5.
- [2] J. ABRHAM AND A. KOTZIG, *Graceful valuations of 2-regular graphs with two components*, Discrete Mathematics, 150 (1996), pp. 3–15.
- [3] I. C. ARKUT, R. C. ARKUT, AND N. GHANI, *Graceful label numbering in optical mpls networks*, in Opticom 2000, International Society for Optics and Photonics, 2000, pp. 1–8.
- [4] A. BASAK, *Mpls multicasting using caterpillars and a graceful labelling scheme*, in Information Visualisation, 2004. IV 2004. Proceedings. Eighth International Conference on, IEEE, 2004, pp. 382–387.
- [5] J. BERMOND, *Graceful graphs, radio antennae and french windmills*, Graph Theory and Combinatorics, Pitman, London, (1979), pp. 18–37.
- [6] G. S. BLOOM, *A chronology of the ringel-kotzig conjecture and the continuing quest to call all trees graceful\**, Annals of the New York Academy of Sciences, 328 (1979), pp. 32–51.
- [7] F. BOTLER, G. O. MOTA, AND Y. WAKABAYASHI, *Decompositions of triangle-free 5-regular graphs into paths of length five*, in The 9th International colloquium on graph theory and combinatorics, 2014.

- [8] L. BRANKOVIC AND I. M. WANLESS, *Graceful labelling: state of the art, applications and future directions*, Mathematics in Computer Science, 5 (2011), pp. 11–20.
- [9] M. EDWARDS AND L. HOWARD, *A survey of graceful trees*, Atlantic Electronic Journal of Mathematics, 1 (2006), pp. 5–30.
- [10] C. GARY, *Introductory graph theory*, 1985.
- [11] J. W. GROSSMAN, F. HARARY, AND M. KLAWE, *Generalized ramsey theory for graphs,  $x$ : double stars*, Discrete Mathematics, 28 (1979), pp. 247–254.
- [12] F.-T. HU AND J.-M. XU, *The bondage number of  $(n - 3)$ -regular graphs of order  $n$* , arXiv preprint arXiv:1109.3931, (2011).
- [13] K. KOH, D. ROGERS, AND T. TAN, *A graceful arboretum: a survey of graceful trees*, in Proceedings of Franco-Southeast Asian Conference, Singapore, vol. 2, 1979, pp. 278–287.
- [14] N. KRAAYENBRINK, F. DE NIJS, AND M. VAVIC, *Symmetries in graceful trees*.
- [15] H. LEI AND H. YANG, *Bounds for the sum-balaban index and (revised) szeged index of regular graphs*, Applied Mathematics and Computation, 268 (2015), pp. 1259–1266.
- [16] J. LYLE, *A structural approach for independent domination of regular graphs*, Graphs and Combinatorics, (2014), pp. 1–22.

- [17] M. MURUGAN AND G. ARUMUGAM, *Are banana trees graceful?*, MATHEMATICS EDUCATION-INDIA-, 35 (2001), pp. 18–20.
- [18] M. MURUGAN AND G. ARUMUGAN, *An algorithm to find graceful numberings of a spl. class of banana trees*, preprint, (2000).
- [19] A. REZA SEPASIAN AND F. RAHBARNIA, *An  $(n \log n)$  algorithm for the inverse 1-median problem on trees with variable vertex weights and edge reductions*, Optimization, 64 (2015), pp. 595–602.
- [20] E. ROBEVA, *An extensive survey of graceful trees*, Udergraduate Honours Thesis, Standford University, USA, (2011).
- [21] A. ROSA, *On certain valuations of the vertices of a graph, theory of graphs (internat. symposium, rome, july 1966), 1967, gordon and breach, n, Y. and Dunod Paris*, pp. 349–355.
- [22] G. SETHURAMAN AND J. JESINTHA, *All banana trees are graceful, advances and applications disc*, Math, 4 (2009), pp. 53–64.
- [23] G. SETHURAMAN AND J. JESINTHA, *All extended banana trees are graceful*, in Proc. Internat. Conf. Math. Comput. Sci, vol. 1, 2009, pp. 4–8.
- [24] M. C. SUPERDOCK, *The graceful tree conjecture: a class of graceful diameter-6 trees*, arXiv preprint arXiv:1403.1564, (2014).
- [25] L. C. UDEIGWE AND G. B. ERMENTROUT, *Waves and patterns on regular graphs*, SIAM Journal on Applied Dynamical Systems, 14 (2015), pp. 1102–1129.



- [26] V. VILFRED, *Families of graceful banana trees, internat, J. Management and Systems*, to appear, (1805).
- [27] D. B. WEST ET AL., *Introduction to graph theory*, vol. 2, Prentice hall Upper Saddle River, 2001.
- [28] G. ZHENBIN, *The labelings of a variation of banana trees*, ARS COMBINATORIA, 94 (2010), pp. 175–181.

VITA

FRANKLINA SAMANI

- Education: B.S. Statistics and Computer Science,  
University Of Ghana,  
Accra, Ghana 2009  
M.S. Mathematical Sciences (Graph Theory),  
East Tennessee State University.  
Johnson City, Tennessee 2015
- Professional Experience: Graduate Assistant, East Tennessee State University,  
Johnson City, Tennessee, 2014 – present  
Customer Service Representative, Liberty Walmart  
Liberty, North Carolina, 2012–2013  
Client Relationship Officer, uniBank Ghana Limited  
Accra, Ghana, 2009–2012