



GRADUATE SCHOOL
EAST TENNESSEE STATE UNIVERSITY

East Tennessee State University
Digital Commons @ East
Tennessee State University

Electronic Theses and Dissertations

Student Works

8-2004

An Analysis of the Conventional Wire Maintenance Methods and Transition Wire Integrity Programs Utilized in the Aviation Industry.

Susan Jeruto Kiptinness
East Tennessee State University

Follow this and additional works at: <https://dc.etsu.edu/etd>

 Part of the [Aeronautical Vehicles Commons](#)

Recommended Citation

Kiptinness, Susan Jeruto, "An Analysis of the Conventional Wire Maintenance Methods and Transition Wire Integrity Programs Utilized in the Aviation Industry." (2004). *Electronic Theses and Dissertations*. Paper 916. <https://dc.etsu.edu/etd/916>

This Thesis - unrestricted is brought to you for free and open access by the Student Works at Digital Commons @ East Tennessee State University. It has been accepted for inclusion in Electronic Theses and Dissertations by an authorized administrator of Digital Commons @ East Tennessee State University. For more information, please contact digilib@etsu.edu.

An Analysis Of The Conventional Wire Maintenance Methods
And Transition Wire Integrity Programs
Used In The Aviation Industry

A thesis
presented to
the faculty of the Department of Technology
East Tennessee State University

In partial fulfillment
of the requirements for the degree
Master of Science in Technology

by
Susan Jeruto Kiptinness
August 2004

J. Paul Sims, Ph.D. Chair
W. Andrew Clark, Ph.D.
Hugh W. Broome

Keywords: Aircraft wiring, Aging Wiring,
Wire Integrity Programs

ABSTRACT

An Analysis Of The Conventional Wire Maintenance Methods
And Transition Wire Integrity Programs
Used In The Aviation Industry

by

Susan Jeruto Kiptinness

Aging aircraft wiring poses a significant threat to both commercial and military aircraft. Recent air disasters involving aging aircraft wiring have made it clear that aging wiring can be catastrophic. Aging of an electrical wiring system can result in loss of critical functions of equipment or loss of information regarding equipment operation. Either result can lead to an electrical failure causing smoke and fire, consequently being a danger to public health and aircraft safety.

Conventional maintenance practices do not effectively manage aging wiring problems. More proactive methods are needed so that aircraft wiring failures can be anticipated and wiring systems can be repaired or replaced before failures occur. This thesis will identify the effects of aging wiring systems, the potential degradation to aircraft safety, and regulations regarding aircraft wire safety. This thesis will evaluate the conventional wire maintenance practices and transition wire integrity programs in the aviation industry.

Copyright 2004 by Susan J. Kiptinness

All Rights Reserved

DEDICATION

I would like to dedicate this work to my family who have supported me through the years and to the Lord Jesus Christ, for His blessings and the strength to pursue my education.

“Delight yourself in the Lord
and He will give you the desires of your heart.”

(Psalm 37:4)

ACKNOWLEDGEMENTS

I would like to express sincere gratitude to Dr. Paul Sims, Chairman of my graduate committee, for his assistance and guidance during the preparation of this thesis and during the course of my study. Acknowledgement is also made to Dr. Andrew Clark and Mr. Hugh Broome for their assistance in the preparation of this thesis. I would also like to thank Dr. Keith Johnson, Chair of the Department of Technology, for his valuable assistance and counsel through the duration of my studies.

Finally, I would like to express my sincere appreciation to my family and friends for their continued support, prayers, and encouragement

CONTENTS

	Page
ABSTRACT.....	2
LIST OF TABLES.....	10
LIST OF FIGURES.....	11
Chapter	
1. INTRODUCTION.....	12
2. BACKGROUND OF AIRCRAFT WIRE SAFETY.....	14
Analysis of Wire Type Effects.....	20
PVC – Polyvinly Chloride/Nylon Insulation.....	20
Aromatic Polyimide Wrapped Insulation.....	20
XL-ETFE- Cross Linked Ethylene Tetra Fluoro Ethylene.....	21
Poly-X-Extruded Aliphatic Polyimide.....	21
3. FEDERAL AVIATION ADMINISTRATION REGULATIONS REGARDING AIRCRAFT WIRE SAFETY.....	25
Wiring Maintenance Practices.....	25
Electrical Load Determination.....	25
Circuit Breaker Protection.....	25
Wire Selection.....	26
Wire Routing.....	27
Clamping.....	29

Wire Bend Radii.....	32
Unused Connectors and Unused Wires.....	33
Wire Replacement.....	35
Wire Splicing.....	36
Wire Terminals.....	37
Grounding and Bonding.....	40
Grounding.....	40
Bonding.....	41
Wire Marking.....	41
Conduits.....	42
Wire Insulation.....	43
Cleaning.....	45
4. CURRENT WIRE MAINTENANCE METHODS UTILIZED IN THE AVIATION INDUSTRY.....	46
Handheld.....	48
Brighton Electronics.....	50
Test Products International.....	50
B & K Precision.....	51
Fluke Corporation.....	51
Kenwood TMI Corporation.....	51
Time Domain Reflectometry.....	52
Riser Bond Instruments.....	54
Phoenix Aviation and Technology.....	55

Bicotest.....	55
Frequency Domain Reflectometry.....	56
Standing Wave Reflectometry.....	57
5. TRANSITION WIRE MAINTENANCE PROGRAMS.....	61
Smart Wiring.....	61
Arc Fault Circuit Breakers.....	65
Nova.....	69
6. ANALYSIS OF THE CONVENTIONAL AND TRANSITION WIRE MAINTENANCE METHODS.....	74
Handheld Multimeter.....	75
Time Domain Reflectometer.....	75
Frequency Domain Reflectometer.....	75
Standing Wave Reflectometer.....	76
Smart Wiring.....	76
Arc Fault Circuit Breakers.....	77
Nova.....	77
7. CONCLUSIONS AND RECOMMENDATIONS.....	81
Conclusions.....	81
Aircraft Wiring Ages and Deteriorates Over Time.....	81
Aging Wiring Severely Impacts Aircraft Safety.....	82
Current Maintenance Programs do Not Effectively Address Aircraft Wiring.....	82
Recommendations.....	83

Incorporate Proactive Wire Maintenance Programs.....	83
Enhance Collaboration among Industry, Academia and the Government.....	83
Improve the Management and Functionality of Wire Systems.....	83
Support Training.....	84
REFERENCES.....	85
APPENDICES.....	91
Appendix A: Acronyms.....	91
Appendix B: Glossary.....	93
Appendix C: Aircraft Wire Table.....	95
VITA.....	103

LIST OF TABLES

Table	Page
1. Incidents Involving Electrical Problems.....	15
2. ATSRAC Sample Aircraft Data.....	20
3. Comparative Properties of Wire Insulation Systems.....	44
4. Wiring Problems, Indicators and Detection Methods.....	47
5. Characteristics of Multimeters and Manufacturers.....	52
6. Features, Advantages and Benefits of Smart Wiring.....	65
7. Advanced Nova Test Capabilities.....	73
8. Analysis Between Conventional and Transition Wire Maintenance Programs...	79

LIST OF FIGURES

Figure	Page
1. TWA Flight 800: The Reconstruction.....	17
2. FAA Aging Systems Program Chronology.....	19
3. Wires Riding on Structure.....	28
4. Wires Improperly Routed.....	29
5. Typical Rubber Clamp.....	31
6. Clamping.....	32
7. Minimum Bend Radii.....	33
8. Spare Wire Termination Using Endcap.....	34
9. Coil and Stow Methods.....	34
10. Adding or Replacing Wires on a Bundle.....	36
11. Staggered Splices.....	37
12. Terminal Stacking Like materials.....	39
13. Terminal Stacking Unlike materials.....	39
14. BK 5380 Digital Multimeter.....	49
15. BK 114B Analog Multimeter.....	49
16. Types of Time Domain Reflectometers.....	54
17. Standing Wave Reflectometer.....	59
18. Smart Wiring Technology Subcomponents.....	63
19. Eaton Arc Fault Circuit Breakers.....	67
20. Troubleshooting Time Costs for an Average Narrow Body Aircraft.....	72

CHAPTER 1

INTRODUCTION

As today's commercial and military aircraft age, so do the hundreds of miles of plastic coated and cloth coated wiring responsible for delivering such critical systems as power and communications in each airplane. Electrical wire in aircraft has become a critical and vital component as aircraft performance and actual flight stability become dependent on avionics (Kuzniar & Slenski, 2002).

Aircraft wiring not only distributes electrical power but provides control and information links between multiple systems and sub-systems. The components that make-up the wiring system include power and control conductors, signal and instrumentation conductors, fiber optic cables, connectors, circuit breakers, relays, power distribution and control panels, and generators. Failure of any of these components can disable an aircraft or compromise an aircrew's ability to control the aircraft (Kuzniar & Slenski, 2000).

Because of the explosion and crash of TWA flight 800 off Long Island, New York in 1996 and the crash of Swissair flight 111 off Nova Scotia, Canada in 1998, a Wire System Safety Interagency Working Group was formed in June 2000 to examine aircraft wiring problems. Their report titled, "Review of Federal Programs for Wire System Safety" published in November 2000, emphasized the importance of aircraft wiring systems and concern of their aging (Lane, 2000).

All wiring systems are subject to aging during their normal service life. Aged wiring is defined as "wire exhibiting degraded performance due to accumulated damage from long-term exposure to chemical, thermal, electrical and mechanical stresses (D'Angelo, Decker, Dicks, Johnson, & White, 2001)." As an example, a build up of damage to the wiring results from

installation and operational stresses and maintenance practices. Aircraft wiring is subject to more rapid deterioration with age in areas of high fluid contamination, vibration, temperature variation, and where it is attached to parts that are moved or removed often (D'Angelo et al., 2001).

As aircraft age, wiring becomes more difficult to maintain with traditional methods. Many of the current maintenance approaches are reactive and only address wiring when a failure cannot be resolved. Inspection and troubleshooting methods presently utilized by maintenance personnel are limited to visual inspection. Visual inspection of individual wires in a bundle or connector is not a practical method because as wire ages it becomes stiff and dismantling the bundle or connector may introduce collateral damage resulting in safety hazards. In addition, wiring may also be difficult to inspect in various parts of an aircraft due to the inaccessibility, for example, wiring inside conduits and behind panels or equipment (D'Angelo et al., 2001).

More proactive methods are needed so that aircraft wiring failures can be anticipated and wiring systems can be repaired or replaced during scheduled maintenance activities. There are numerous techniques employed in the aviation field by maintenance technicians. New technologies are being developed to facilitate inspection and detection of wire defects before they affect electrical system operation and improve overall wire system integrity. Among the most promising technologies are advanced reflectometry methods, smart wire systems, and arc fault circuit breakers. Remaining challenges include identifying the miniature insulation breaks by means of impedance/spectroscopy technology and radio frequency leak test methods. This thesis seeks to identify the aging wiring problem in aircraft, highlight some of the current wire maintenance practices used in the aviation industry, and analyze advanced technologies being developed to combat the aging wiring problem.

CHAPTER 2

BACKGROUND OF AIRCRAFT WIRE SAFETY

As the aircraft fleet ages, the challenge for the aviation community is to maintain a high standard of safety in an economic environment that is intensely competitive. The Federal Aviation Administration (FAA), in partnership with the aviation community, is leading the way in ensuring the safety of the commercial fleet (Smith, 2002).

The FAA and the National Transportation Safety Board (NTSB) have reported hundreds of potential hazardous incidents of smoke and electrical problems in aircraft cabins and cockpits. Table 1 lists a few examples of incidents involving electrical problems (Brown & Gau, 2001).

Table 1

Incidents Involving Electrical Problems (Brown, & Gau, 2001)

DATE	AIRLINE/ AIRCRAFT TYPE	PROBLEM	WIRE FAILURE DUE TO:	RESOLUTION
12/2000	Delta Airlines 219, L- 1011	Electrical fire due to arcing of the windshield heat wire bundle	Arcing of aircraft structure, Adel clamp & a 30-wire bundle	NTSB investigation of this incident is ongoing
11/2000	Air Tran 956, DC-9- 32	Electrical fire to the left forward areas of the fuselage & cargo compartment from fuselage stations (FS) 237-313 & damage to cabin floor.	Arcing and damaged wiring around FS 237 and pin-pin shorts of electrical connectors	NTSB recommends FAA to require all DC-9 operators to visually inspect electrical connectors at FS 237 for evidence of lavatory rinse fluid contamination & for presence of a drip shield above disconnect panel in accordance with Boeing Alert Service Bulletin DC9-24A190
11/2000	American Airlines 1683, MD- 80	Electrical fire in the aircraft wiring above the cabin ceiling panels	Lightning strike caused arcing in the aircraft's wiring	NTSB investigation of this incident is ongoing
10/2000	Continental Airlines flight 1579	Electrical fire in the left jump seat area near the registration certificate holder	Several heavy gauge electrical wires severed and welded together on the opposite side of the jump seat wall	Corrective actions that Continental Airlines have taken are to remove all certificate holders on EPC wall & install new 3-slot certificate holder on galley wall -has honeycomb backing.
8/2000	Air Tran Flight 913, DC-9	Smoke due to electrical arcing in the bulkhead behind captain's seat	Arcing ignited interior panels	NTSB recommends FAA to equip interior panels with access panels/ports to apply extinguishing agent behind interior panels
9/99	Delta Airlines 2030, MD- 88	Smoke in cabin due to smoldering insulation blanket	Arcing from the static port heater ignited the insulation blanket & became a self-sustaining fire	NTSB issued FAA recommendations contained in A-01-003, A-01-004 & A-01-005

Swiss Air Flight 111 and TWA Flight 800 are examples of two high profile fatal crashes that resulted from faulty electrical wiring. On September 2nd 1998, Swiss Air Flight 111, an MD-11 aircraft crashed off the coast of Nova Scotia in Canada. The aircraft en route from John F. Kennedy (JFK) International Airport, New York to Geneva, Switzerland, crashed into the North Atlantic killing all 215 passengers and 14 crewmembers. According to the Canadian Transportation Safety Board (TSB): final accident report number A98H0003 dated March 27th 2003, the in flight fire “most likely started from an electrical arcing event that occurred above the ceiling on the right side of the cockpit near the cockpit rear wall (Fiorino, 2003).” The arcing of one or more wires in turn ignited the inflammable cover material on nearby thermal acoustic insulation blankets and quickly spread. A segment of electrical cable from the in flight entertainment network is believed to be associated with one or more of the arcing events (Fiorino, 2003).

On July 17th 1996, Trans World Airlines (TWA) Flight 800, a Boeing 747-131, crashed in the Atlantic Ocean near East Moriches, New York. The flight was operating as a scheduled international passenger flight from John F. Kennedy (JFK) International Airport New York to Paris, France. All 212 passengers and 18 crewmembers were killed and the airplane was destroyed. According to the National Transportation Board (NTSB): final accident report number NTSB/AAR-00/03 dated August 23rd 2000, it was determined that the probable cause of this accident was an explosion of the center wing fuel tank (CWT) resulting from ignition of the inflammable fuel/air mixture in the tank. The source of the ignition energy for the explosion could not be determined with certainty, but, of the sources evaluated by the investigation, the most likely source was a short circuit outside of the center fuel tank that allowed excessive voltage to enter it through electrical wiring associated with the fuel quantity indication system.

Figure 1 shows the wreckage from TWA flight 800 (TWA flight 800: The Reconstruction, 1999).



Figure 1. TWA Flight 800: The Reconstruction (1999).

The investigation of the TWA Flight 800 fuel tank explosion uncovered possible damaged and degraded wiring. Following this mishap, President Clinton established the White House Commission on Aviation Safety and Security (WHCSS) on August 22nd 1996. The Commission was chartered to study matters involving aviation safety and security, including air traffic control, and to develop a strategy to improve aviation safety and security, both domestically and internationally. The commission, whose membership included representatives from the aircraft and air travel industry, government agencies, and organizations of crash victim families made several recommendations. Recommendation 1.9 stated: “In cooperation with airlines and manufacturers, the FAA’s Aging Aircraft program should be expanded to cover nonstructural systems (White House Commission on Aviation Safety and Security, 1997).”

The report explained further that, “The Commission is concerned that existing procedures, directives, quality assurance, and inspections may not be sufficient to prevent safety related problems caused by the corrosive and deteriorating effects of non-structural components of commercial aircrafts as they age (White House Commission on Aviation Safety and Security, 1997).”

On October 2nd 1998, the FAA developed the Aging Non-Structural Systems Plan to address the recommendation of the White House Commission on Aviation Safety and Security. In order to fully address the WHCSS recommendation on aging systems, an Aging Non-Structural Systems Study team was formed. This team carried out an inspection of systems in several aging airplanes and met with FAA Principal Maintenance inspectors to make preliminary evaluation of the need for additional work relative to the Commission’s concerns. The team concluded that further work was warranted and that the industry involvement in this work was essential. The FAA chose to address these recommendations through an Aging Transport Systems Rulemaking Advisory Committee (ATSRAC) (Hollinger, 1999).

The Aging Transport Systems Rulemaking Advisory Committee (ATSRAC) is a Federal Advisory Committee and is responsible for providing public recommendations to the Federal Aviation Administration (FAA). The committee was chartered on January 19th 1999 by FAA order 1110.127 page 1 that stated “The committee’s primary task is to propose such revisions to the Federal Aviation Regulations and associated guidance material as may be appropriate to ensure that non-structural systems in transport airplanes are designed, maintained, and modified in a manner that ensures their continuing operational safety throughout the service life of the airplanes (Hollinger, 1999).” Figure 2 shows the Federal Aviation Administration (FAA) aging systems program chronology (Sadeghi, 2002).

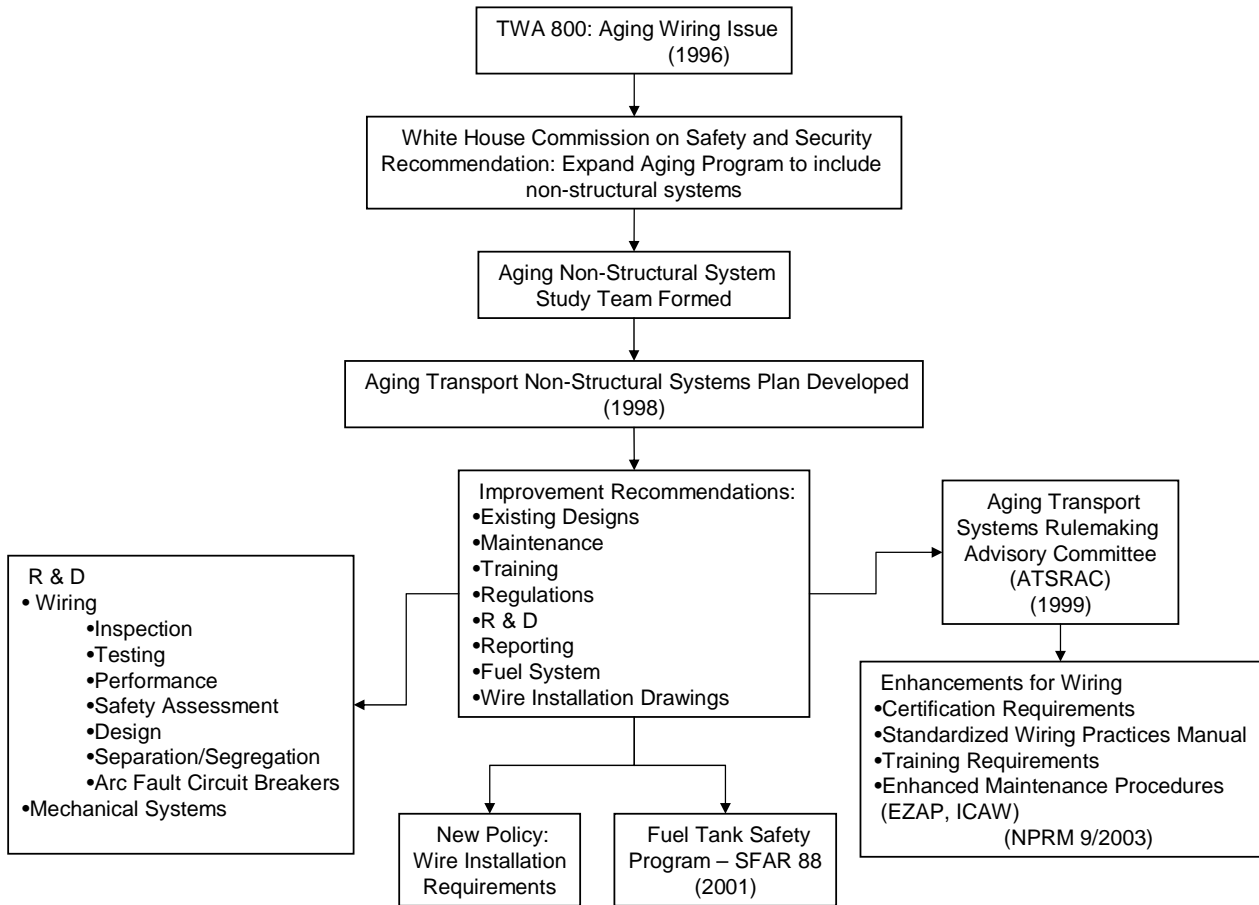

Figure 2. FAA Aging Systems Program Chronology (Sadeghi, 2002).

Subsequent to the crash of TWA Flight 800, the FAA initiated a study of the condition of aged aircraft wiring under the guidance of the Aging Transport Systems Rulemaking Advisory Committee (ATSRAC). On 29th December 2000, the FAA’s Aging Transport Systems Rulemaking Advisory Committee (ATSRAC) published their final report documenting the Transport Aircraft Intrusive Inspection Project (An Analysis of the Wire Installations of Six Decommissioned Aircraft). The intrusive inspection phase of the ATSRAC study examined the condition of wiring on six different commercial aircraft models meeting certain wire type, age and retirement requirements. Five of the aircrafts were recently retired (A300, DC-9 (1), B-747,

L1011, DC-9 (2)) and one was decommissioned but not retired (DC-10). These aircraft are shown in Table 2 (Smith, 2002).

Table 2

ATSRAC Sample Aircraft Data (Smith, 2002) * See Appendix C

<i>Aircraft Sampled</i>	<i>A300</i>	<i>DC-9</i>	<i>B-747</i>	<i>DC-9</i>	<i>L1011</i>	<i>DC-10</i>
Inspection	9/99	12/99	2/00	5/00	6/00	6/00
Year Mfr	1978	1967	1973	1971	1972	1979
Hours	39,713	74,558	100,241	66,801	63,618	61,334
Cycles	27,078	100,017	20,348	75,446	26,256	18,818
Retired	7/99	9/99	5/99	12/99	6/99	5/00 ³
Wire Type*	Polyimide	PVC/G/N	Poly-X	PVC/G/N	Polyimide	XL-ETFE

Analysis of Wire Type Effects

PVC – Polyvinyl Chloride/Nylon Insulation

For the two aircraft, the vast majority of the wire degenerative conditions and especially the cracked insulation conditions seemed indicative of the low hydro-retention and thermal performance of the insulation material and particularly of the polyamide (nylon). Comparison of the data for the two DC-9 aircraft with PVC/Glass/Nylon (especially the heat damage data) showed that other factors other than wire type have a major effect on the state of the wire (Smith, 2000).

Aromatic Polyimide Wrapped Insulation

The degenerative condition data for this wire wrapped insulation showed relatively low levels of vibration and chafing damage conditions, indicative of this insulation's good mechanical performance. The Aircraft data showed a wide variation between the two aromatic polyimide aircraft inspected in regard to cracking reported. The L1011 exhibited significantly more

cracking. The inspection data showed topcoat damage on both the A300 and L1011 aircrafts (Smith, 2000).

XL-ETFE – Cross-Linked Ethylene Tetra Fluoro Ethylene

The cross-linked ETFE data showed that the aircraft thermal, fluid, and chemical contamination environments did not adversely influence the aging characteristics of this insulation. The results of the insulation resistance test and the dielectric withstand voltage test done in the Sandia and Raytheon laboratories confirmed that there was little change in the insulative properties of the ETFE material as a result of exposure to these environments (Smith, 2000).

Poly- X- Extruded Aliphatic Polyimide

This wire insulation displayed characteristic radial cracking mode. This was later verified with Sandia Laboratory testing. There was evidence of arcing found as well (Smith, 2000).

The inspections of the ATSRAC study involved three distinctive tasks:

1. Detailed visual inspection with or without invasive follow-up
2. Nondestructive testing (NDT)
3. Laboratory analysis

The data from the visual inspections, nondestructive testing, and laboratory analysis were analyzed to accomplish two objectives:

- a. To evaluate the adequacy of visual inspection for detecting deteriorating wire installations.
- b. To determine the condition of wire in aged aircraft

The intrusive inspection focused on six significant categories of wire degradation:

- i. Degraded wire repairs or splices

- ii. Heat damaged or burnt wire
- iii. Vibration damage or chafing
- iv. Cracked insulation
- v. Arcing
- vi. Insulation delamination (Smith, 2000).

The visual inspections completed during the intrusive inspection phase of the ATSRAC study were more detailed than the visual inspection procedures normally followed as a part of routine aircraft maintenance. After completion of the detailed visual inspection, nondestructive testing (NDT) was carried out on the aircraft before wire bundle samples were removed for laboratory analysis. The two methods of nondestructive testing used were the Lectromechanical Design Company's Del Test and Eclipse testing (D'Angelo et al., 2001).

Nondestructive testing (NDT) was done to locate insulation damage, which may include cuts, cracks, splices or abrasions, conductor shorts, and opens. When the wire bundles arrived in the laboratory for detailed analysis of individual wires, they were tested once more for insulation damage. The core conductor from each wire specimen was also removed for further examination. Laboratory testing on randomly selected wire was performed at both Sandia National Labs and Raytheon. Nondestructive testing (NDT) was primarily used to verify all defects had been identified during visual inspection and to make certain that the process of removing the samples from the aircraft had not induced new damage. Results of the nondestructive testing (NDT) done on the wire bundles before aircraft removal and laboratory analysis exposed a number of significant defects that had gone unidentified using the intensive detailed visual inspection method. These results indicate visual inspection is least effective in finding defects in aircraft wiring as compared to automated or instrumented inspection techniques (Smith, 2000).

Using visual inspection as the key wire management tool raises some concern especially due to the large amount of contamination on the wiring inspected during the intrusive inspection phase of the ATSRAC study. The accumulation had probably taken place over a number of years. Accumulation of fluid contaminants (e.g. water waste, hydraulic) and solid debris (e.g. drill shavings, foreign objects) on/in many wire bundles in each of the aircrafts studied was quite extensive, making it impossible to visually inspect them (Smith, 2000).

General visual inspection is a technique used to inspect the condition of both commercial and military aircraft wiring on an ongoing basis and to deal with aging mechanisms and damage resulting from normal operation and maintenance. The nondestructive testing (NDT) and laboratory analysis done during the ATSRAC study showed more wire damage than the general visual inspection; therefore, it can be assumed that several wiring defects go undetected during normal maintenance operations. In most cases, these wire defects are found only after system failures, insulation charring, smoke, or electrical fire has taken place (D'Angelo et al., 2001).

Results from the intrusive inspection ATSRAC study illustrated that visual inspection can be effective in identifying certain conditions:

- a. Heat damaged or burnt wire
- b. Vibration damage or chafing

Some examples of conditions that may be visually undetectable are:

- a. Cracked insulation
- b. Arcing
- c. Insulation delamination
- d. Degraded repairs or splices
- e. Damage and degradation hidden under accumulated lint or other contaminants

- f. Damage inside protective wrap materials, conduit or in inaccessible areas
- g. Damage or degradation hidden inside wire bundles (Smith, 2000).

General visual inspection techniques limit the extent to which aircraft wire damage and degradation can be detected, hence the need for more wire diagnostic equipment (automated/instrumented). If aircraft safety is to be enhanced, inspection methods must be able to identify precursors before defects become visually evident causing charring, smoke, and/or electrical fires.

CHAPTER 3

FEDERAL AVIATION ADMINISTRATION REGULATIONS

REGARDING AIRCRAFT WIRE SAFETY

Historically, aircraft wiring was installed and treated as a “fit and forget” commodity rather than as an indispensable system. While there is a tendency to ignore wire systems, there is a need to manage aging wire systems so that they continue to function safely. The government has developed regulations, codes, and standards for aircraft safety. Both the aviation industry and government have developed operational practices that focus on maintaining the integrity of the aircraft wiring system (Brown & Gau, 2001).

Wiring Maintenance Practices

Electrical Load Determination

Electrical load determination ensures each aircraft electrical bus can safely sustain a predetermined amount of load, which is based on the electrical capacity of the aircraft’s overall electrical distribution system. The load analysis is determined to make sure that all electrical devices can be safely controlled or managed by the aircraft’s electrical system (Aircraft Wiring Practices, 2002).

When adding an electrical device, a load analysis should be carried out to ensure that the new load on the bus can be powered effectively and that there is adequate electrical power margin to avoid overloading the bus (Federal Aviation Administration, 1998).

Circuit Breaker Protection

All electrical wires must have some means of circuit protection. Electrical wire should be protected with circuit breakers or fuses positioned as close as possible to the electrical power source. The manufacturer of electrical equipment will generally specify the fuse or breaker to be

used when installing the respective equipment. In addition, SAE ARP 1199 may also be referred to for recommendation practices (Federal Aviation Administration, 1998).

According to FAA Advisory Circular (AC) 25.1357, automatic protective devices should be used to minimize distress to the electrical system and hazards to the airplane, in the event of wiring faults or serious malfunction of the system or connected equipment. Circuit breakers are designed as circuit protection for the aircraft wiring and not for protection of black boxes or other components. A circuit breaker is rated so that it will open before the current rating of the wire attached to it is exceeded or before the cumulative rating of all loads connecting to it are exceeded, whichever is lowest (Federal Aviation Administration, 1998).

FAA Advisory Circular (AC) 25-16 states that crews should not attempt to reset a circuit protection device in flight. For the reason that resetting the circuit breaker can greatly influence the degree of arcing damage to the aircraft wiring. Each successive attempt to restore an automatically disconnected circuit protection device, can lead to progressively worsening effects from arcing. Use of a circuit breaker as a switch is not recommended because it reduces the life of the circuit breaker.

Wire Selection

Aircraft service imposes severe environmental conditions on electrical wire; for that reason, selecting the correct wire is critical to the performance of the aircraft. Wires should be sized so that they accomplish the following:

1. Have sufficient mechanical strength to allow for service condition
2. Do not exceed allowable voltage drop levels
3. Are protected by circuit protection devices
4. Meet circuit current carrying requirements

In general, wires smaller than size number 20 should be provided with additional support at terminations, such as strain relief cramps, connector grommets, shrinkable sleeving or telescoping bushings. Additionally, they should not be used in areas of excessive vibration, repeated bending or frequent disconnection from screw termination. When determining the current capacity of the aircraft wires, the following factors should be considered (Federal Aviation Administration, 1998):

1. Effects of heat aging on wire insulation
2. Maximum operating temperature
3. Single wire or wires in a harness
4. Altitude

Bare copper develops a surface oxide coating at a rate dependent on temperature. This oxide film is a poor conductor of electricity and impedes wire determination. Consequently, all aircraft wiring has a coating of tin, silver, or nickel that have far slower oxidation rates.

1. Tin coated copper: < 150° C
2. Silver coated wire: < 150° C
3. Nickel coated wire: < 260° C

When a replacement wire is needed the maintenance manual for the aircraft must first be reviewed to verify if the Original Aircraft Manufacturer (OAM) has approved any substitution. If there is no substitute, then the original aircraft manufacturer must be contacted for acceptable replacement (Federal Aviation Administration, 1998).

Wire Routing

All aircraft wiring should be installed so that it is mechanically and electrically sound and neat in appearance. FAA Advisory Circular (AC) 65 states, “Wires and bundles should be routed

parallel with, or at right angles to, the stringers or ribs of the area involved". The only exception is coaxial cable, which is routed as directly as possible. According to Aircraft Wiring Practices, the following guidelines should be used when routing wires.

1. Eliminate potential for chafing/abrasion against structure or other components.
2. Position to minimize use as handhold or support.
3. Reduce exposure to damage by maintenance crews or shifting cargo.
4. Avoid battery electrolytes or other corrosive fluids.

Figure 3 shows an example of wire chafing (Aircraft Wiring Practices, 2002).

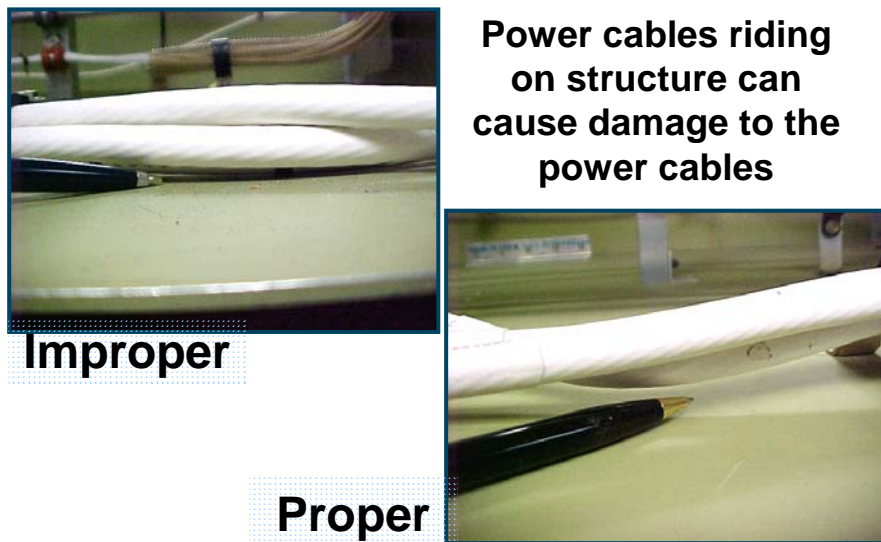

Figure 3. Wires Riding On Structure (Aircraft Wiring Practices, 2002).

Figure 4 shows wires in a bundle not properly routed (Aircraft Wiring Practices, 2002)

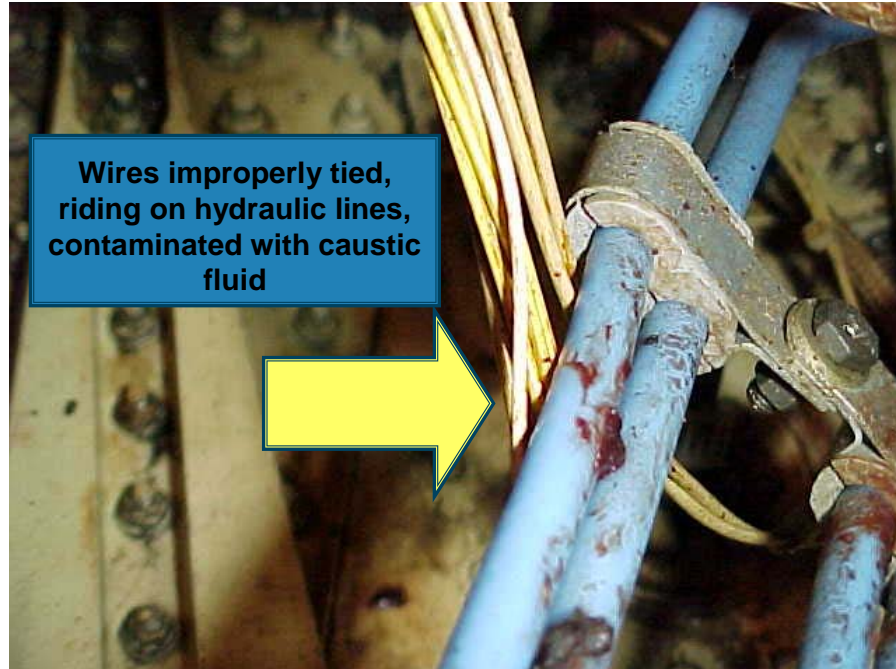

Figure 4. Wires Improperly Routed (Aircraft Wiring Practices, 2002).

Clamping

Clamps and other primary support devices should be made of materials that are compatible with their installation and environment, which is temperature, fluid resistance, exposure to ultraviolet light, and wire bundle mechanical loads. Clamps should be spaced at intervals not exceeding 24 inches. Clamping intervals may need to be decreased in high vibration areas or areas around structural intrusions in order to provide support. FAA Advisory Circular (AC) 43.13-1b mandates these guidelines:

1. Clamps on wire bundles should not allow the movement of the bundle through the clamp when a slight axial pull is applied.

2. Clamps on RF cables should have a snug fit to inhibit the cable from moving freely through the clamp but still allow for cable movement through the clamp when a light axial pull is applied.
3. Plastic clamps or cable ties should not be used where their failure could result in interference with movable controls, wire bundle contact with moveable equipment, or chafing damage to essential or unprotected wiring.
4. Clamps should be installed with their attachment hardware located above them.

Clamps lined with nonmetallic material should be used to support the wire bundle along the run. Tying may be used between clamps but nonetheless it should not be regarded as a substitute for adequate clamping. Adhesive tapes are prone to age deterioration and are not acceptable as a clamping means.

Clamp pinching is a frequent problem in aircraft wiring. This takes place when there is too much wiring in a clamp or when the clamp is not properly installed. To solve this problem, clamps on wire bundles should be chosen to have a snug fit without pinching wires (Aircraft Wiring Practices, 2002).

Figure 5 illustrates a typical rubber clamp (Aircraft Wiring Practices, 2002).

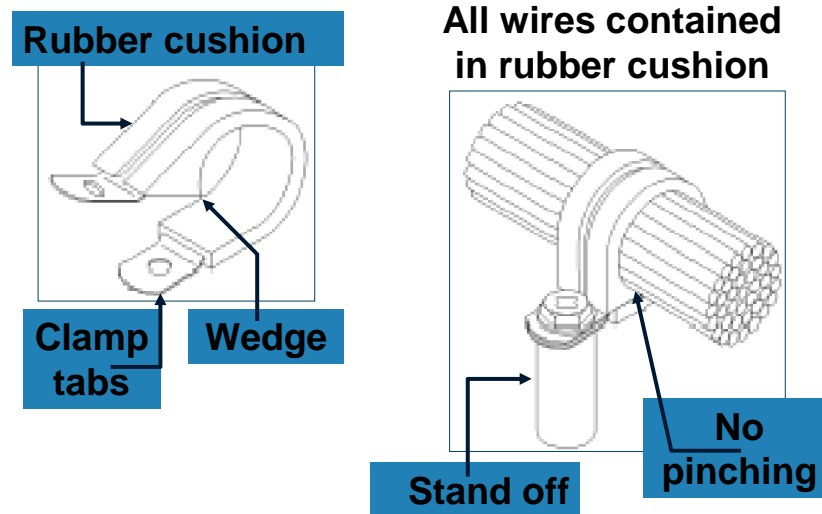

Figure 5. Typical Rubber Clamp (Aircraft Wiring Practices, 2002).

Figure 6 shows the correct method for clamping wires (Aircraft Wiring Practices, 2002).

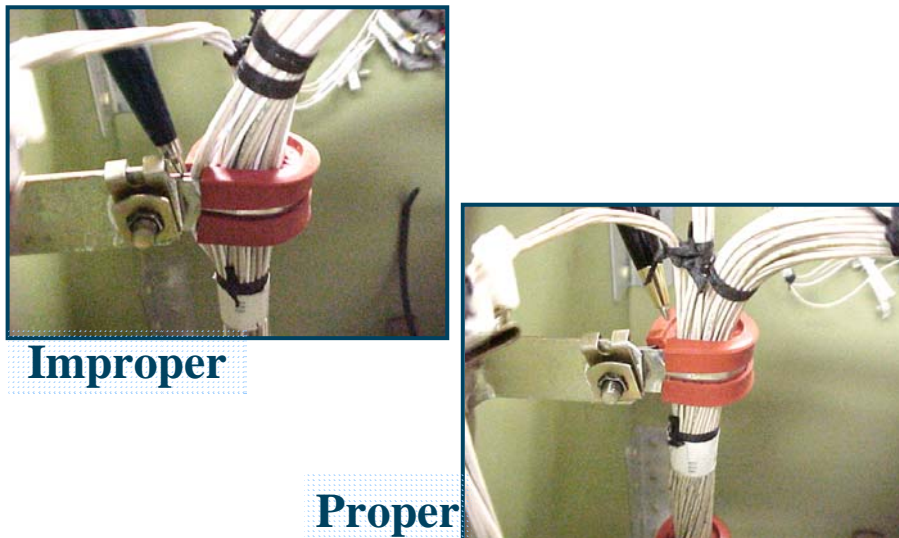

Figure 6. Clamping (Aircraft Wiring Practices, 2002).

Wire Bend Radii

According to Advisory Circular (AC) 43.13-1b, the minimum radius for bends in wire groups or bundles should not be less than 10 times the outside diameter of the largest wire or cable. The only exceptions are at terminations (3 times the diameter), RF cables (6 times the diameter), and thermocouple wires (20 times the diameter).

Figure 7 illustrates the proper bend radii for three different wiring scenarios (Aircraft Wiring Practices, 2002).

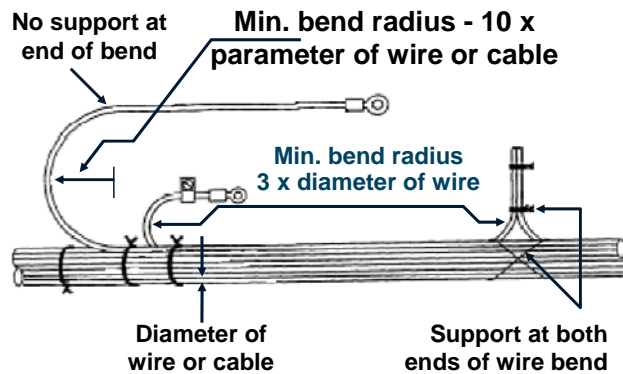

Figure 7. Minimum Bend Radii (Aircraft Wiring Practices, 2002).

Unused Connectors and Unused Wires

Connectors may contain some contact cavities that are not used. Depending on the type of connection installed, unused connector contact cavities may need to be sealed well to prevent damage to the connector or have a string wire installed. Unused wires can be individually tied into a bundle or secured to a permanent structure (Federal Aviation Administration, 1998).

Installing prefabricated end caps is an efficient way of protecting unused wires with exposed conductors. Coil and stow methods are utilized to secure the excess length of a wire bundle or to secure wires bundles that are not connected to any equipment for future installations (Aircraft Wiring Practices, 2002).

Figure 8 illustrates an example of the use of a prefabricated end cap (Aircraft Wiring Practices, 2002).

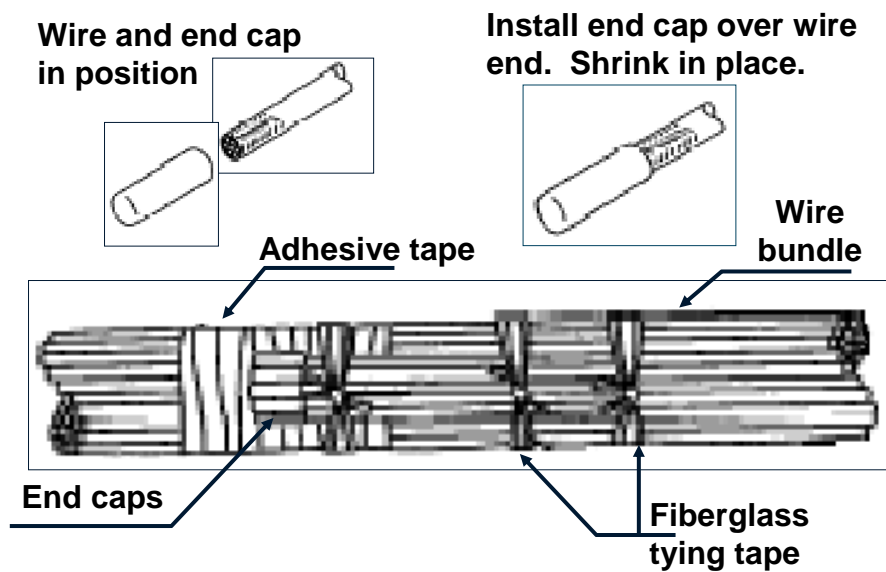
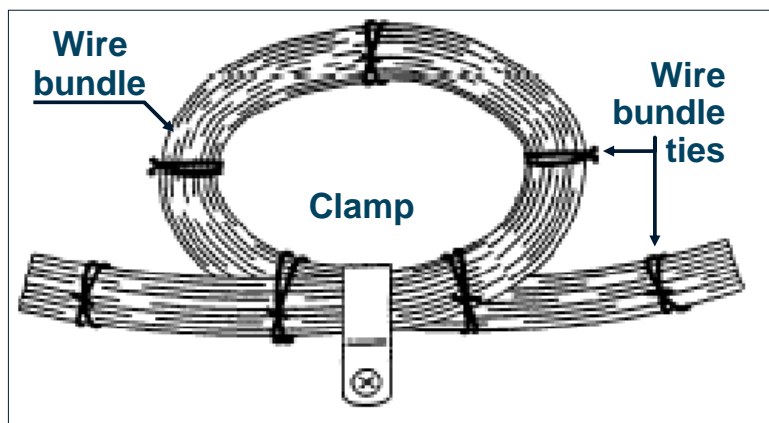

Figure 8. Spare Wire Termination Using Endcap (Aircraft Wiring Practices, 2002).

Figure 9 shows coil and stow methods used to secure wire bundles (Aircraft Wiring Practices, 2002).



Coil and stow short/long wire bundles in low vibration areas

Figure 9. Coil and Stow Methods (Aircraft Wiring Practices, 2002).

Wire Replacement

FAA Advisory Circular (AC) 43.13-1b requires aircraft wiring to be replaced with equivalent wire when any of the following defects are located:

1. Wiring that has been subjected to chafing or fraying.
2. Wiring that show evidence of cracked outer insulation when slight flexing is applied.
3. Wiring that has weather cracked outer insulation.
4. Wiring that may have been exposed to electrolyte or on which the insulation appears to be deteriorating due to the effects of electrolyte.
5. Wiring that shows visible evidence of having been crushed or kinked.
6. Shielded wiring on which the metallic shield is frayed or corroded.
7. Wiring exhibiting evidence of breaks, cracks, dirt, or moisture in the plastic sleeving.
8. Wiring that has its insulation saturated with engine oil, hydraulic fluid, or another lubricant.
9. Sections of wire that have splices occurring at less than 10 ft intervals unless specifically authorized.

Wires that are added or replaced on a wire bundle should be routed in the same way as the other wires in the wire bundle.

Figure 10 illustrates the correct procedure for wire replacement (Aircraft Wiring Practices, 2002).

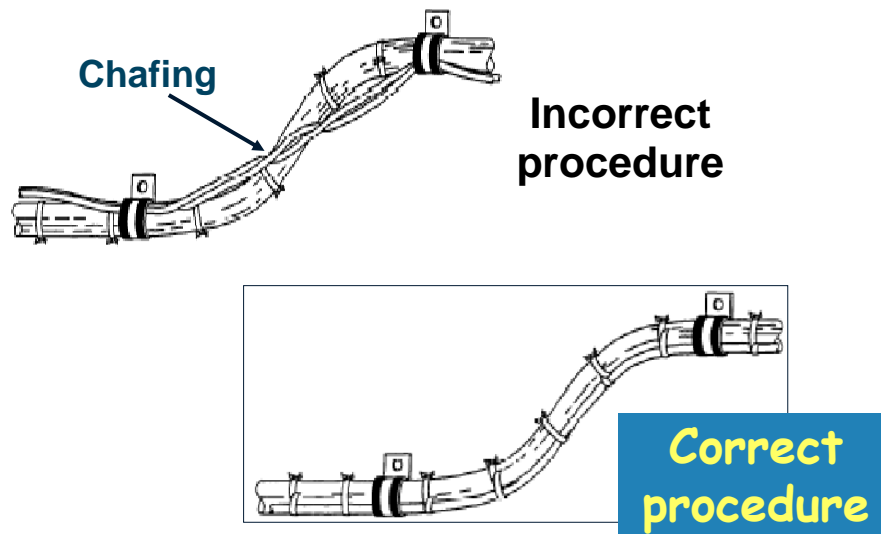

Figure 10. Adding or Replacing Wires on a Bundle (Aircraft Wiring Practices, 2002).

Wire Splicing

Splicing is acceptable on aircraft wiring as long as it does not have an effect on the reliability and the electro-mechanical characteristics of the wiring. Splicing of power wires, coaxial cables, multiplex bus, and large gauge wire should be avoided. The only exception is if the wire splicing has approved data. FAA Advisory Circular (AC) 43.13-1b mandates the following guidelines when splicing wire:

1. Keep splicing to the minimum.
2. Avoid splicing wires in high vibration areas.
3. Splicing in bundles should be staggered to minimize any increase in the size of the bundle.

4. Splicing of individual wires should have engineering approval and the splice should allow for periodic inspection.
5. Use a self-insulated splice connector if possible. Nevertheless, if a non-insulated splice connector is used the splice should be covered with plastic sleeving that is secured at both ends.
6. Environmentally sealed splices that conform to MIL-L-7928 are reliable in SWAMP (Severe Wind and Moisture Problems) areas. However, if a non-insulated splice is to be used, the splice should be covered with dual wall shrink sleeving of a suitable material (AC 43.13-1b).

Figure 11 shows the use of staggered splices in wire bundles (Aircraft Wiring Practices, 2002).

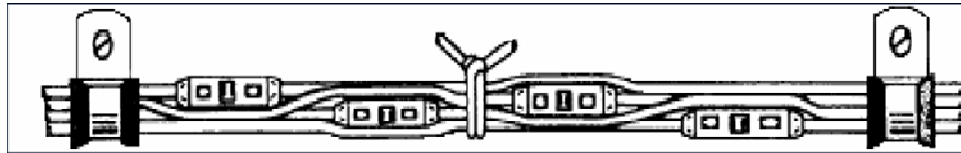

Figure 11. Staggered Splices (Aircraft Wiring Practices, 2002).

Wire Terminals

Terminals are connected to the ends of electrical wires to facilitate connection of the wires to terminal strips or items of equipment. The tensile strength of the wire-to-terminal joint should be at least equal to the tensile strength of the wire itself. The resistance of the wire-to-terminal joint should be small relative to the normal resistance of the wire. According to FAA Advisory Circular (AC) 43.13-1b, the following factors should be considered when selecting wire terminals:

1. Current rating

2. Wire size (gauge) and insulation diameter
3. Conductor material compatibility
4. Stud size
5. Insulation material compatibility
6. Application environment

A terminal strip is fitted with barriers to prevent the terminals on adjacent studs from contacting each other. Terminal strips should be inspected for loose connections, metallic objects that may have fallen across the terminal strip, dirt and grease accumulation. Such conditions can cause arcing, which may lead to a fire or system failures.

Terminal lugs should be used to connect wiring to terminal block studs or equipment terminal studs. The maximum number of terminal lugs and a bus to be connected to any one stud is four and three respectively. Terminal lugs should be chosen with a stud hole diameter that matches the diameter of the stud. In instances where there is a variation in the diameter of the terminal lugs attached to a stud, the greatest diameter should be placed on the bottom and the smallest diameter on the top (Federal Aviation Administration, 1998).

Terminals that are made of like materials can be stacked directly on top of each other. On the other hand, terminals that are made of unlike materials, for example aluminum and copper a cadmium-plated flat washer is used to isolate the dissimilar metals. A terminal that is completely assembled should have a minimum of two to three threads showing on the stud when the nut is torqued properly.

Figures 12 and 13 illustrate terminal stacking materials and methods (Aircraft Wiring Practices, 2002).

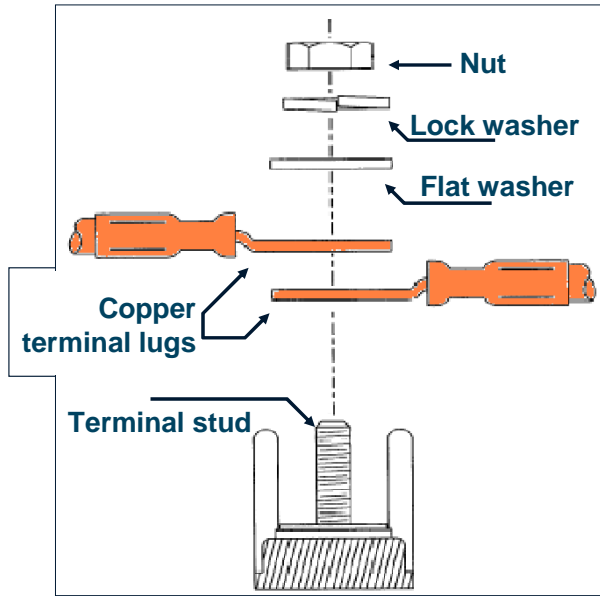

Figure 12. Terminal Stacking Like Materials (Aircraft Wiring Practices, 2002).

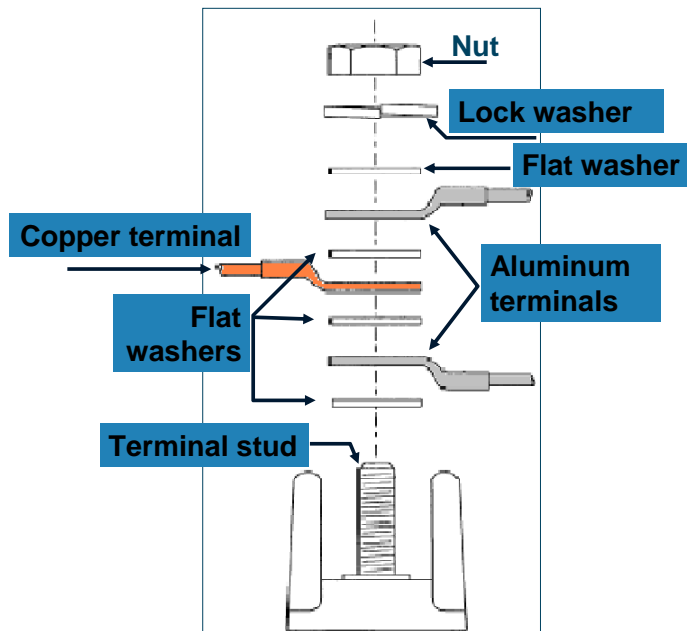

Figure 13. Terminal Stacking Unlike Materials (Aircraft Wiring Practices, 2002).

Grounding and Bonding

Grounding. Grounding is defined as the “process of electrically connecting conductive objects to either a conductive structure or some other conductive return path for the purpose of safely completing either a normal or fault circuit (Federal Aviation Administration, 1998).”

According to Advisory Circular (AC) 65-15A, bonding and grounding connections are made in aircraft electrical systems to accomplish the following:

- a. Protect aircraft and personnel against hazards from lightning discharge.
- b. Provide current return paths.
- c. Prevent development of radio-frequency potentials.
- d. Protect personnel from shock hazards.
- e. Provide stability of radio transmission and reception.
- f. Prevent accumulation of static charge.

Advisory Circular 65-15A recommends the following general procedures and precautions when making bonding or grounding connections.

- a. Bond or ground parts to the primary aircraft structure where possible.
- b. Make bonding or grounding connections so that no part of the aircraft structure is weakened.
- c. Bond parts individually if feasible.
- d. Install bonding or grounding connections against smooth, clean surfaces.
- e. Install bonding or grounding connections so that vibration, expansion or contraction, or relative movement in normal service will not break or loosen the connection.

Bonding. Bonding refers to the “electrical connecting of two or more conducting objects not otherwise adequately connected (Advisory Circular 65-15A).” FAA Advisory Circular (AC)

43.13-1b mandates the following bonding specifications:

1. Equipment Bonding

Low impedance paths to aircraft structure are generally required for electronic equipment to provide radio frequency return circuits and to facilitate reduction in electromagnetic interference.

2. Metallic Surface Bonding

All conducting objects located on the exterior of the airframe should be electrically connected to the airframe through mechanical joints, conductive hinges, or bond straps, which are capable of conducting static charges and lightning strikes.

3. Static Bonds

All isolated conducting paths inside and outside the aircraft with an area greater than 3 in² and a linear dimension over 3 inches that are subjected to electrostatic charging should have a mechanically secure electrical connection to the aircraft structure of adequate conductivity to dissipate possible static charges.

Wire Marking

Correct identification of electrical wires and cables with their circuits and voltages are essential to provide, “safety of operation, safety to maintenance personnel, and ease of maintenance (Federal Aviation Administration, 1998).” The method of identification used to mark the wires should not damage the characteristics of the wiring. Original wire marking should be maintained to facilitate installation and maintenance. Wire identification marks should include

letters and numbers that identify the wire, the circuit it belongs to, wire gauge size, and any other information to relate the wire to a wiring diagram. It is equally important to make all wire markings legible in size, type, and color.

According to Advisory Circular (AC) 43.13-1b, the following guidelines should be used when marking wires in aircrafts:

1. Identification markings should be placed at each end of the wire and at 15-inch maximum intervals along the length of the wire.
2. Wires less than 3 inches long do not need to be identified. Wires between 3 and 7 inches long should be identified approximately at the center.
3. Wire identification code should be printed to read horizontally (from left to right) or vertically (from top to bottom).

The two techniques used to mark wires or cables are direct marking and indirect marking. Direct marking is accomplished by printing the cable's outer covering. Indirect marking is accomplished by printing a heat shrinkable sleeve and installing the printed sleeve on the wire or cables outer covering. Wire marking should be permanent so that environmental stresses during operation and maintenance will not affect legibility.

Conduits

Conduits are mainly used for mechanical protection of wires and cables. Guidelines to follow when inspecting conduits are as follows:

1. Check for proper end fitting.
2. Absence of abrasion at the end fittings.
3. Adequate drain holes free of obstructions.
4. Minimized abrasion or damage from moving objects.

The size of conduit for a specific wire bundle application should be selected accurately to allow for proper maintenance and possible future circuit expansion. To acquire the right conduit size, specify the conduit inner diameter approximately 25 % larger than the maximum diameter of the wire bundle (Federal Aviation Administration, 1998). Advisory Circular (AC) 43.13-1b lists installation guidelines to avoid conduit problems.

1. Do not locate conduit where service or maintenance personnel might use it as a handhold or footstep.
2. Provide inspectable drain holes at the lowest point in a conduit run. Drilling burrs should be removed carefully.
3. Support conduit to prevent chaffing against structure and to avoid stressing its end fittings.

Wire Insulation

Wire insulation should be selected based on FAA flame resistance, smoke emission requirements and the environmental characteristics of the wire routing areas. Insulating materials should be selected for the best combination of the following characteristics:

1. Abrasion resistance
2. Corrosion resistance
3. Dielectric strength
4. Flame resistance
5. Mechanical strength
6. Resistance to fluids
7. Smoke emission
8. Arc resistance

9. Heat distortion temperature

The four most common types of insulating materials used in aircraft today are shown in Table 3 (Aircraft Wiring Practices, 2002).

Table 3

Comparative Properties of Wire Insulation Systems (Aircraft Wiring Practices, 2002)

Polymer	Mil Specifications	Desirable Properties	Limitations
PTFE (Teflon)	22759/12	260°C thermal rating, low smoke/non-flame, high flexibility	Cut-through resistance, “creep” at temperature
ETFE (Tefzel)	22759/16	Chemical resistance, abrasion resistance, ease of use	High temperature, cut-through, thermal rating (150°C)
Aromatic Polyamide (Kapton)	81381	Abrasion/cut-through, low smoke/non-flame, weight/space	Arc-track resistance flexibility
Composite (TKT)	22759/80-92	High temperature rating (260°C), cut-through resistance, arc-track resistance	Outer layer scuffing

When choosing wire insulation it is imperative to not only to seek the best balance of electrical, mechanical, chemical, and thermal properties but also inherent flame and/or smoke resistance (Aircraft Wiring Practices, 2002).

Cleaning

All aircraft wiring needs to be kept clean throughout the life of the aircraft. This can be accomplished by cleaning wiring periodically during heavy maintenance when hidden areas are exposed. Care should be taken when wiring is being cleaned especially as the aircraft and its wiring age. As aircraft age, the wire insulation becomes brittle, so moving of wiring during cleaning should be minimized. Vacuuming and soft brushes may be used to remove dirt, lint, and other foreign objects (Aircraft Wiring Practices, 2002).

CHAPTER 4
CURRENT WIRE MAINTENANCE METHODS UTILIZED
IN THE AVIATION INDUSTRY

Wiring integrity and safety issues have surfaced as a major aviation crisis associated with the loss of Swissair flight 111 in 1998 and TWA flight 800 in 1996. Aircraft wiring is the vital electrical and optical network that transmits the data, signals and power to and from systems. Wiring problems cause loss of signals, system shutdowns, smoke, fires, and explosions. In addition, wiring problems cause millions of dollars in troubleshooting and maintenance (Blemel & Furse, 2001).

The National Transportation Safety Board (NTSB) and the U.S. Federal Aviation Administration (FAA) have adequately “heightened (their) awareness of the importance of maintaining the integrity of aircraft wiring (NTSB 303).” Ensuring flight safety entails more immediate detection of electrical malfunctions and better fire suppression methods. However, avoiding flight tragedies involves improving wire inspection techniques.

According to the National Transportation Safety Board, aircraft wiring is visually inspected, but “a large portion of an aircraft’s electrical wiring is not readily visible” because it is “bundled with dozens of other wires” or “blocked from view by other structures or components (NTSB 194).”

Visual inspection refers to “a non-intrusive check examining wiring for chafing and signs of arc tracking using floodlights, flashlights and mirrors. Detailed visual inspection refers to intrusive removal of clamps along with disconnecting harnesses to check for cracks and exposed conductors with illumination and magnifying glasses (Blemel & Furse, 2001).”

Table 4 lists several common wiring problems, primary indicators, and current techniques used to correct them (Blemel, & Furse, 2001).

Table 4

Wiring Problems, Indicators and Detection Methods (Blemel, & Furse, 2001)

Impending Failure	Primary Indicator	Detection Method
Badly chafed wiring	Worn spots	Visual inspection Radar and thermal conductivity
Defective connections	Major impedance change Localized heating	Reflectometry, Thermal Detectors, end-to-end tests
Ticking short circuits	Electromagnetic Interference Arc tracking	Visual inspection Reflectometry
Solid short circuits	Circuit breaker trips	Reflectometry
Deteriorated insulation	Cracks, broken areas	Visual inspection
Exposed conductors	Loss of functionality Fires	Visual inspection Reflectometry
Corrosion	Eventual loss of signal/data	Visual inspection
Water in harness	Loss of data/signal	Reflectometry

Today's typical aircraft wiring inspections are visual and they do not get to the heart of aircraft wiring problems. Failures such as severed wires are detected, but individual visual inspections do not expose the slow but continuous erosion of wiring that results from thousands of miles flown in the aircraft's lifetime. In most cases, visual inspection entails pin to pin tests by technicians with voltmeters and is considered to be slow, expensive, error prone, and not able to detect many of the wiring anomalies (Tambouratzis, 2001).

A number of insulation cracks cannot be identified by visual inspection. These cracks are usually smaller than a human hair but can nevertheless cause operational problems or loss of an aircraft. Wire insulation may appear to be in perfect condition, but as it ages it becomes weak and prone to danger. Wires in bundles wrapped in tape and covered with coaxial metal sheathing are impossible to inspect visually. In reality, the twisting and pulling of aircraft wires to locate wire failures is considered intrusive and recognized as often doing more harm than good.

Visual inspection detects “only 25 to 39 percent of the defects that (can be) identified” using “electronic inspection techniques” performed by automated test equipment, such as “electrical continuity or resistance tests, insulation resistance and capacitance tests (NTSB 194-5),” and time domain, frequency domain, and standing wave reflectometry (Hast & Madaras 2001).

Handheld

Handheld tools are classified as battery operated, single or multifunction meters approximately the size of a handheld multimeter. The readout format for multimeters can be either analog or digital; however, digital displays are preferred. Both analog and digital multimeters are used to find electronic and electrical problems (D’Angelo et al., 2001).

Analog multimeters are instruments that are used to measure electrical quantities for instance voltage, current, resistance, frequency, and signal power. Advanced analog multimeters will incorporate more features such as capacitor, diode and integrated chip testing modes. Analog multimeters display measurement values using a dial, typically a moving pointer or needle (GlobalSpec, 2004).

Digital multimeters are instruments that are used to measure electrical quantities for example voltage, current, resistance, frequency, temperature, capacitance, and time period measurements. Advanced digital multimeters contain additional features such as capacitor, diode, and integrated

chip testing modes. Digital multimeters display measurement values on a digital screen. In general, the multimeters have between three and six digits but some units will have larger screens that can display seven or more digits (GlobalSpec, 2004).

Figures 14 and 15 show examples of digital and analog multimeters (Tequipment.net, 2004).



Figure 14. BK 5380 Digital Multimeter

(Tequipment.net, 2004).



Figure 15. BK114B Analog Multimeter

(Tequipment.net, 2004).

Handheld multimeters are used in aircraft wire testing for identification of open or short circuits, indication of fault, indication of wire insulation degradation, and isolation of intermittent faults (D'Angelo et al., 2001).

In February 2000, the Air Force Research Laboratory (AFRL), Materials and Manufacturing Directorate started a comprehensive program to look into the condition of the wiring systems of representative fighter, bomber, and transport aircraft. An international team conducted and

documented site surveys of the three Air Force depots and several field level maintenance operations. To accomplish the overall objective, site visits were made to identify types of wire system faults that exist and to identify the types of tools and techniques needed to detect the faults. Results from the research demonstrated that current visual inspection methods and handheld tools only identify one fourth of all wiring problems discovered. In addition, the research showed that a multimeter is the most often used piece of test equipment for troubleshooting aircraft wiring. It takes two maintenance personnel a minimum of two to three hours to verify continuity on a 100-120-wire harness using a multimeter. This piece of test equipment is usually preferred since it is easy to use, portable and easy to interpret the results (D'Angelo, Dicks, & Slenski, 2000).

The following is a list of some multimeter manufacturers and handheld multimeters typically used to perform electronic tests and measurements in aircrafts.

Brighton Electronics

Brighton Electronics manufactures the following digital multimeters: Summit series with model numbers 35, 45, 50, 60, 70, 85, 86, 610, 620, 622, and 786. Summit series digital multimeter unique features are as follows (Brighton Electronics, 2002):

- a. Compare mode and relative mode capability
- b. Record mode including minimum, maximum, and average values
- c. Triple readout display

Test Products International

Test Products International manufactures digital multimeters, which include: TPI models 120, 126, 133, 135, 153, 163, and 183 (Test Products International, 2004).

B & K Precision

B & K Precision Corporation manufactures both analog and digital multimeters. BK models 114B and 117B make up the analog meters; the digital meters include BK models 2405A, 2407A, 2408, 2700, 2703B, 2704B, 2706A, 2707A, 2708, 2880A, 2890, 5360, 5370, 5380, and 5390. B & K multimeters are characterized by the following features (B & K Precision, 2004):

- a. Range hold capability
- b. Peak hold capability

Fluke Corporation

Fluke Corporation manufactures the following digital multimeters: Fluke series 10, 73/77, 80, 110, 112, 170, 179, 180, and 867B. Fluke multimeters exemplify the ability to record minimum to maximum readings with time stamp (Fluke, 2004).

Kenwood TMI Corporation

Kenwood TMI Corporation manufactures the following digital multimeters: Kenwood series DL-90, DL-92, DL-94, and DL-97. Kenwood multimeters are characterized by the following features (Kenwood, 2001):

- a. Maximum and minimum data memory
- b. Data storage and recall capability
- c. Peak hold capability
- d. Square wave output function
- e. Timer output function
- f. Current input connection alarm that generates alarm buzzer sound when an attempt is made to measure voltage while a test lead is still connected to the current input.

Table 5 shows a comparison between multimeter features and manufacturers

Table 5

Characteristics of Multimeters and Manufacturers

Manufacturer	Display Count	Basic DC Volt Accuracy	True RMS measurements	RS 232 Interface	Analog Bar Graph	Auto/Manual Ranging	Safety Standards	Data Hold	Backlight Display	Price Range
Brighton Electronics	2000-4000	0.3%-0.5%	Yes	Yes	Yes	Yes	CE & IEC 1010 CAT II	Yes	Yes	\$105.95-\$215.95
TPI	2000-4000	0.3%-0.5%	No	No	Yes	Yes	CE/UL	Yes	No	\$32.95-\$159.95
B & K	2000-50,000	0.25%	Yes	Yes	Yes	Yes	CE	Yes	Yes	\$35-\$325
Fluke	3200-50,000	0.025%-0.9%	Yes	Yes	Yes	Yes	IEC 1010 CAT III, IV	Yes	Yes	\$109-\$579
Kenwood	3200-5000	0.06%-0.5%	Yes	Yes	Yes	Yes	EN55011 IEC 801-2,3,4	Yes	Yes	\$115-\$455

The handheld multimeter has the following limitations (D' Angelo et al., 2001):

1. It is a time consuming process especially when trying to isolate the wire system faults pin-by-pin.
2. It requires two people to allow for connection at both ends.
3. There are no data archiving or retrieving capabilities.
4. It is an extensive process to physically locate wire failures.

The handheld multimeter does not adequately measure all aspects of aircraft wiring anomalies, for that reason other test equipment that have enhanced capabilities over current multimeters have been developed and implemented.

Time Domain Reflectometry

Time domain reflectometry is “the analysis of a conductor (wire, cable or fiber optic) by sending a pulsed signal into the conductor and then examining the reflection of that pulse (Furse,

& Waddoups, 2001).” The incident and reflected signals are both seen on the wire simultaneously, although their time domain signatures are separated in time because of the travel time delay down the wire. By analyzing the reflected pulse, the length of the wire, impedance and the location of open or short circuits can be determined. Large changes in the wire (open or short circuits) cause large reflections that are easy to measure and small changes in the wire (junctions or frays etc), cause smaller reflections that are hard to detect (Furse, 2003).

Time domain reflectometry electronics consist of a fast rise time pulse generator, fast voltage sampler, and a microprocessor to analyze the results. The time domain reflectometer determines the length of the wire based on the time it takes for the reflection to return to the source. The polarity of the reflection can be used to further examine the wire fault. A reflected pulse that increases in amplitude denotes an open circuit (high impedance). Conversely, a reflected pulse that decreases in amplitude signifies a short circuit (low impedance) (Parker n.d.).

A time domain reflectometer can display the information it receives in two formats. The first and more conventional method is to display the actual waveform of the wire. The display, which is either a cathode ray tube or a liquid crystal display, will show the transmitted pulse generated by the time domain reflectometer and any reflections that are caused by impedance changes along the length of the wire. The second method is a numeric readout that specifies the distance in feet or meters to the first major reflection caused by a fault along the wire. Some time domain reflectometers will identify if the fault is an open or short circuit.

Figure 16 shows the different types of time domain reflectometers (Riserbond, 2004).



Figure 16. Types of Time Domain Reflectometers (Riserbond, 2004).

The following is a list of some time domain reflectometer manufacturers typically used to perform electronic tests and measurements in aircrafts.

Riser Bond Instruments

Riser Bond Instruments is a division of Radiodetection Ltd that specializes in the design and manufacturing of time domain reflectometers, which include models 1205CXA, 1270A, 1550, 3200, 3300, and 6000. Riser Bond Instruments' time domain reflectometers are characterized by the following features (Riser Bond, 2004):

Super-store waveform storage stores all of the waveform information shown both on and off the screen.

- a. Wave view software allows information stored in the time domain reflectometer to be uploaded to a computer waveform and can be archived, adjusted, or analyzed on the computer while the time domain reflectometer carries out other tests.
- b. Auto search makes it possible for the operator to quickly and easily step through preset distance range and pulse width settings to accomplish other manual operations.
- c. Auto noise filter offers a unique multilevel filtering system to filter out various kinds of interferences on the wire.

- d. Independent cursors allow the operator to measure the distance between any two points along the wire, thereby allowing the user to maintain the accuracy of the test.
- e. Complies to ISO 9001 and CE safety standards

Phoenix Aviation and Technology

Phoenix Aviation and Technology has developed a fully automated time domain reflectometer unit that offers a wider range of fault diagnostics and prognostics with exact location and interpretation of the wire faults. This technology allows the operator to monitor a single conductor wire condition, circuit status, and load analysis in real time (Furse & Haupt, 2001).

Bicotest

Bicotest designs and manufactures precision time domain reflectometers and cable test instruments for cable fault location, test and measurement, installation, and maintenance on power distribution cables, twisted pair cables, and coaxial cables. T 631 time domain reflectometer is a high specification wire fault locator used for fault location on aircraft fire detection systems. T 631 time domain reflectometer is characterized by the following features (Bicotest, 2002):

- a. Genuine two-nanosecond pulse width gives excellent close fault finding detection and examination of the condition of the wire.
- b. It gives the best short-range performance of three meters and long-range performance of twelve kilometers.
- c. Availability of 13 operating ranges with zoom facility make it possible to identify wire features that are close together or nearby.

- d. Pulse widths can be selected automatically to allow for easy fault location or manually for uniform return loss measurement.
- e. Computer compatibility ensures waveforms can be analyzed, stored, and re-loaded for on-site comparison of waveforms.
- f. Large, clear waveform display of full trace for accurate diagnosis.

A time domain reflectometer has the following limitations:

1. It is expensive and bulky.
2. The high voltage spike (1000 volt signal) used in the testing process poses a major problem to sensitive electronics and may cause extensive damage.
3. Miles of wiring inside an aircraft make it very difficult to get access and test.
4. The testing procedure requires disconnecting wiring which intrinsically increases the risk to the wiring through wear and tear on the connectors and the wiring itself and possible damage to nearby structures (Blemel, & Furse, 2001).

Frequency Domain Reflectometry

Frequency domain reflectometry sends a set of stepped-frequency sine waves down the wire. These sine waves travel to the end of the wire and are reflected back to the source. Electronic circuitry at the source end of the wire is used to detect these reflected sine waves and analyzed to determine wire characteristics, including wire length and load, capacitance, inductance, resistance, impedance, and the location of an open or short circuit (D'Angelo et al., 2001).

A frequency multiplier is used to analyze the phase change between the incident and reflected wave, which is then used to compute the length and termination of the wire and other anomalies along its length. A small impedance value of the wire under test signifies a short circuit at the

point of termination. In contrast, a large impedance value of the wire denotes an open circuit at the point of termination (Furse, 2003).

Frequency domain reflectometer circuitry is comprised of a stepped frequency sine wave generator and either a frequency counter, a received signal strength indicator chip, or a frequency multiplier and DC voltage measurement hardware. A frequency domain reflectometer is less bulky than a time domain reflectometer for that reason; it can be used in more locations that are otherwise more difficult to get access to with bulkier systems like a time domain reflectometer. In addition, a frequency domain reflectometer system uses less power than a time domain reflectometer system making it a safe method to use in detecting impedance changes in aircraft wiring (Furse & Nilesh, 2004).

Frequency domain and time domain reflectometry are some of the current maintenance methods used to detect wire failures in aircraft systems. Despite the fact that these techniques permit identification and localization of hard wiring failures, they are unable to monitor degradation associated with wire insulation and corrosion. Furthermore, these reflectometry systems are only performed when the aircraft is out of service, and they are unable to predict wire failures and identify sources of damage before wire failures arise in aircrafts.

Standing Wave Reflectometry

A standing wave reflectometer sends a high frequency sinusoidal waveform down the wire and detects any interruption in the wire impedance, thereby determining wire characteristics such as integrity, length, and impedance. Impedance is a measure of the total opposition to current flow in a circuit. Any change in the impedance of the wire causes a reflection of the transmitted signal to take place at the point where there is interference in impedance uniformity. By the nature of the reflections that are generated on the wire, characteristics are noted using power and

voltage measurements to find out whether the impedance discontinuity is caused by a short or an open circuit. The incident and reflected signals are merged together to produce a standing wave on the line. The peaks and nulls of the standing wave provide information on the length of the terminating load of the wire. (Furse & Waddoups, 2001). The amplitude of the standing wave has maximum and minimum points on the wire that are dependent upon the frequency of the incident wave (Furse & Woodward, 2003).

Eclipse International's ESP standing wave reflectometer is a unique device that has been analyzed for its ability to locate a short circuit or an open circuit on a wide range of wiring, such as triaxial, multistranded, and even twisted pair. The ESP standing wave reflectometer is a handheld, battery-operated test set with the capability of testing up to 1,000 feet from the test unit and short or open circuit detection accuracy of 0.2 %, which equates to mere centimeters. Once the test is carried out, the standing wave reflectometer reports the wiring system as okay, degraded, or failed. If a fault exists, it identifies the location of the fault. Results from the standing wave reflectometer can be downloaded to a laptop using its serial data port. The graphical display on the standing wave reflectometer indicates the condition of the wire. A good systems performance will be illustrated by a perfect sine wave, a degraded system will display an averaged sum of distorted sine waves where the peaks appear dipped and a failed system will show nothing but unrecognizable sine waves. The unit cost for a standing wave reflectometer is \$5,500 (Maher, 2004).

The ESP standing wave reflectometer is characterized by the following features (Maher, 2004):

1. Liquid crystal display that offers systems status, menu items, wire type, and the "ready for test" display.

2. Ability to locate wiring faults in aircrafts in inaccessible areas.
3. Performs a non-destructive multiple frequency test protocol per wire path.
4. Menu driven test procedure and has ten programmable settings for various conductor types.
5. Resultant test data on the computer screen can be saved as text files for future reference against other installation.
6. Operating range of -20 to +60 degrees Celsius.
7. Rechargeable battery with an 8 hour operating life.

Figure 17 is an example of a standing wave reflectometer (Pappas, 2001).



Figure 17. Standing Wave Reflectometer (Pappas, 2001).

A standing wave reflectometer is simple in its design making it less expensive to manufacture than a typical time domain reflectometer. In addition, the standing wave reflectometer promotes efficient utility with its portable nature, selectable frequency range, and automatic operation (Nieto, 2000).

Implementation of the standing wave reflectometer in the Navy has resulted in fewer in-flight electrical fires, reduced wiring related false equipment removals, fewer maintenance hours, and rapid identification of wiring anomalies. Similarly, the applications of the standing wave

reflectometer in the commercial sector offers reduced man-hours, faster diagnostic test phases, and faster aircraft turn around time from the ground (Commercial Technology Transition Officer, 2003). The overall benefits of the standing wave reflectometer are reduced time and effort to troubleshoot, repair and validate repairs, enable proactive maintenance, and most of all lower total operating costs (Nieto, 2000).

Current visual inspection methods, handheld multimeters, time domain reflectometers, and frequency domain reflectometers are the primary means to detect degradation in installed aircraft wiring. Standing wave reflectometry is recognized as a means of localizing and identifying hard faults. Nonetheless, it is not currently able to locate defects in wiring insulation, but the technology could be adapted to do so. Due to the inherent limitations of the above techniques, researchers are now looking at several inspection and maintenance protocols that include smart wire systems and arc-fault circuit breakers. The aviation industry has embarked on several new initiatives to develop advanced wiring technologies that will play an important role in enhancing aircraft safety and operational availability.

CHAPTER 5

TRANSITION WIRE MAINTENANCE PROGRAMS

As an aircraft wiring system ages, the wiring system becomes more susceptible to anomalies and failures, which can result in safety problems. The current maintenance approach of flying an aircraft until a system failure is encountered is becoming more difficult to continue. New maintenance methods will need to be incorporated to effectively manage aging wiring systems in aircrafts.

There are several wire maintenance systems available today or under development for detecting aircraft wiring problems. Among the most promising technologies are smart wire systems for continual on- the- spot testing and arc fault circuit breakers. Honeywell's Nova wire integrity program was also developed to be a data-intensive wire inspection diagnostic tool.

Smart Wiring

Smart wiring is the “embedding of intelligence and sensors in the wiring system to manage the health of the wiring (Arnason, Field, & Furse, 2001).” The components of the smart wiring system include a frequency domain reflectometer, on-board processor, environmental sensors, and wireless communication system integrated into a single miniaturized unit, hundreds of which can be embedded in the wiring system.

Smart connectors and smart wiring signify a new approach to troubleshooting not only the aircraft wiring but also the systems that are connected to the wiring. Smart wiring technology can operate in real time during flight and can locate intermittent problems that occur during take-off, cruise, and landing.

Management Sciences, Inc. (MSI) has been developing the hardware and software technology for smart wiring systems and smart connectors since the start of a Joint Strike Fighter

(JSF) contract. The Joint Strike Fighter contract launched a research program in 1997 to explore design of a new format of smart wiring, using time embedded processors and signal processing for detecting opens and shorts in aircraft wiring (Blemel A. & Blemel G., 2000).

The U.S. Naval Air Systems Command estimates that \$75 million is spent annually on wiring related troubleshooting and maintenance, emphasizing the fact that finding shorts and opens in aircraft wiring is costly. Smart connectors and smart wiring products significantly diminish the costs of aircraft maintenance. At a rate of 20% application, the projected savings in labor would surpass \$15 million per year. The savings that result from preventing the loss of an aircraft due to loss of systems, explosions, or fires may well exceed \$50 million per occurrence (Blemel, 2000).

Smart wiring system is comprised of a microelectronics module with integral software signal processing and sensors for the purpose of wiring signal and integrity. For smart wiring, the module is enclosed inside a wiring integration unit or junction box added to conventional wiring. For smart connectors, the module is connected to specifically modified connectors inside a bulkhead-mounted unit. Sensing signals are issued to examine the aircraft wiring and digitizers are utilized to monitor signals. Digital signal processing is used to find short, open and frayed conditions in the aircraft wiring (Blemel, 2000).

Smart wiring technology combines hardware sensing and software algorithms and is comprised of the following subcomponents:

1. Smart wiring harness – a variant of a smart connector that is assembled by placing the electronics module into the wiring integration unit or junction box. A smart wiring harness uses ordinary connectors in its design.
2. Smart connector – a bulkhead mounted unit provides a single processor with outreach capabilities to inspect several wiring harnesses equipped with smart connector.

3. Data collection system – smart wiring technologies carry out baseline measurements and direct readings with sensors to resolve if a wiring connector, the wiring itself, or the unit repaired is at fault or degraded.

Figure 18 shows the subcomponents of smart wiring technology (Arnason, 2001).

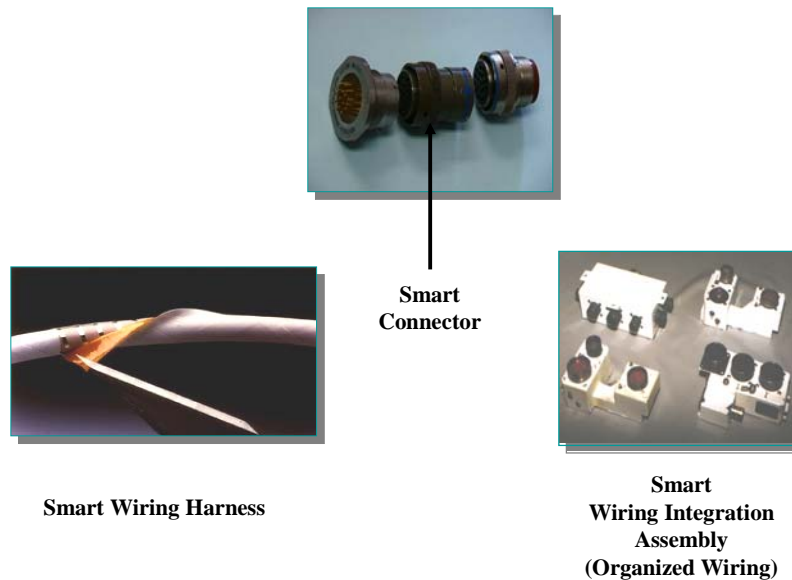

Figure 18. Smart Wiring Technology Subcomponents (Arnason, 2001).

Sensors used in the smart wiring technology weigh just a few ounces using Micro Machined Electromechanical Systems (MEMS) and Application Specific Integrated Circuits (ASIC) that weigh just a few milligrams each. Data acquired from the sensors are accessible for either on-board or off-board analysis and is used by prognostic algorithms to determine the health of the aircraft wiring (Tambouratzis, 2001). Data retrieved from the sensors is collected by one of several methods, which consist of RF radio link, infrared link, and direct interface to a technician's personal or hand held computer (Blemel, 2000).

Smart wiring system can accurately identify the point of damage consequently, saving hours of troubleshooting time across aircraft bulkheads. Technicians will be directed to exact locations of wiring short, open, and frayed conditions rather than using current labor-intensive techniques. In addition, the smart systems can monitor the components attached to the wiring and examine whether a component is failed or is working. The smart wiring system is able to observe performance of the component after reinsertion to guarantee its return to original condition (Tambouratzis, 2001).

In May 2000, the office of Naval Research funded a two-year project for further research and development of smart wiring leading to flight demonstrations in late 2001 (Blemel, 2000). The Navy estimates savings that will result from the full implementation of the smart wiring technology into Navy aircraft will be significant including the following:

1. 200,000 to 400,000 fewer organizational man-hours per year.
2. \$34.5 million annual savings from reduced mission aborts and fewer mission capable hours.
3. 80% reduction of in-flight electrical fires and subsequent loss of aircraft resulting in \$27.3 million annual savings.

Smart wiring systems are able to detect the causes of problems before they happen, thereby making them very effective in preventing the occurrence of the problem through early warnings to the crew and the maintenance personnel. The smart systems can have significant impacts for enhancing aircraft safety, minimize false maintenance, and facilitate proactive maintenance that will save costs, time, and human lives. A summary of the benefits of the smart wiring system is highlighted in Table 6 (Blemel, 2000).

Table 6

Features, Advantages and Benefits of Smart Wiring (Blemel, 2000)

Features	Advantages	Benefits
Measures signals	Reduce need for additional hardware, particularly important in aircraft where flight certification is required	Lower integration costs
Detects and locates shorts, frays and opens	Saves hours of time and use of equipment for troubleshooting	Eliminates a cartload of test equipment
Integrate into existing systems with minimal change	No additional hardware required	Lower integration costs
No ancillary processing	All processing done in algorithm; no secondary operations	Reduced complexity

Smart wiring systems apply to new and legacy aircraft wiring systems. For legacy aircraft, modules can be added during a scheduled wiring system upgrade; a complete wiring system replacement is not necessary. According to Naval Air Systems Command, initial insertion of the smart wiring systems is scheduled for 2006 in P3 aircraft (Blemel & Furse, 2001).

Arc Fault Circuit Breakers

The primary device for protecting an aircraft from the hazards of electrical failures is the circuit breaker. Circuit breakers currently used in most civilian and military aircraft are comparable to those found in most household circuit breaker fuse boxes. Circuit breakers in use today are heat sensitive bimetal elements that trip only when a large current passes through the circuit long enough to heat the element (Furse & Haupt, 2001). They generally do not protect

against small sparks that can result from aging or frayed wires, causing either arcing between individual wires or between the wire harness and the aircraft structure.

Circuit breakers are designed to protect the wiring from overheating related to wiring overload or short circuits and not arcing. An arcing fault draws less current than a hard fault and occurs intermittently while generating high temperatures that can ignite nearby combustibles. In most cases, arcing faults occur in damaged or deteriorated wires and cords, which is a common occurrence in aging aircraft (Phillips, 2004). Microscopic cracks, abrasions, or broken insulation in aged wire will likewise instigate arcing faults.

Electrical arcing generates very hot localized temperatures nonetheless, the arcing might not radiate enough energy for the circuit breaker or fuses to heat up sufficiently so that they trip or remove power from the circuit rapidly enough to avoid serious damage to the electrical wiring. Existing circuit breakers take up to several hundred milliseconds to diagnose a fault and then trip. During that time, the adjacent wires heating up can result in failed systems, structural burns and possible loss of aircraft (Phillips, 2004). To avoid the potential catastrophe that electrical arcing could create, the Federal Aviation Administration (FAA) in cooperation with the Naval Air Systems Command (NAVAIR) and the Office of Naval Research have developed aircraft arc detecting circuit breakers.

Arc fault circuit breakers use integrated electronics to detect when arcs or intermittent short-circuiting occurs in the wiring, then instantly isolates the circuit from the rest of the system greatly reducing the threat of an electrical arc fire. Arc fault circuit breakers take about five seconds to detect a fault and trip, thereby reducing the chance of damaging the surrounding wiring, other equipment, and the aircraft structure (Phillips, 2004).

Arc fault circuit breakers use integrated electronics to analyze the current on the wire at sub millisecond intervals. Time and frequency domain filtering are used to extract the arc fault signature from the current waveform. This signature may be integrated over time to discriminate by means of pattern matching algorithms between a normal current and a sputtering arc fault current. Consequently, ordinary processes (example, a motor being turned on and off) can be differentiated from the random current surge that takes place with arcing (Furse & Haupt, 2001).

Most testing of the arc fault circuit breakers has been carried out by the commercial airline industry with several aircraft firms using them on an experimental basis. Quantas Airlines has flown more than 1,000 hours on an arc fault circuit breaker designed by Eaton Aerospace, whereas Delta Airlines has already started installing them aboard their Boeing 737s (Phillips, 2004).

Figure 19 shows Eaton arc fault circuit breakers (Arnason, 2001).



Figure 19. Eaton Arc Fault Circuit Breakers (Arnason, 2001).

According to the Federal Aviation Administration, the advances and growth of radio communications and other electronic technologies have initiated the High Intensity Radiated

Field (HIRF) phenomena. At the present time, there are more than 500,000 emitters in the United States and Western Europe contributing to the electromagnetic environment. Aircraft are exposed to the HIRF environments that radiate from high-powered radio and television frequency transmitters, radar and satellite uplink transmitters, and large microwave communication systems (Phillips, 2004).

Research indicates that aircraft electrical and electronic systems that carry out critical functions such as aircraft flight and navigation may not be able to withstand the electromagnetic fields generated by HIRF. The vulnerability of aircraft electrical and electronic systems to malfunction when exposed to HIRF can pose a threat to aviation safety systems (Phillips, 2004).

The High Intensity Radiated Field (HIRF) testing performed at the Navy Electromagnetic Radiation Facility involved exposing the aircraft, a C-9 Skytrain, in high to low frequency emitters. Emitters were located at varied angles to test not only the arc fault circuit breaker, but also the cables leading to the breakers. The arc fault circuit breaker took one more step toward fleet deployment by passing the Joint Aeronautics Association's High Intensity Radiated Field testing in January 2004. Although the HIRF testing is complete, the arc fault circuit breaker must still go through lightning test and there are plans to test various sizes of the circuit breaker for possible use in attack aircraft (Phillips, 2004)

According to the NAVAIR Aging Aircraft Integrated Process Team (IPT), arc fault circuit breakers could cut down wiring maintenance costs by 80 % and provide an annual savings of \$12 million. Benefits of the arc fault circuit breakers will not only be in terms of troubleshooting, repair time reduction, and cost reduction but also in flight safety.

Nova

Honeywell has long recognized the importance of safety, reliability, diagnostics, physics of failure, and prognostics in an aircraft. Honeywell has led a team of industry experts and has developed the Nova Wire Integrity Program. According to Francois Gau, Director of Marketing at Honeywell Aerospace Services, “the reliability and safety of wiring in older aircraft is a major concern of operators throughout the industry (Shavarini p.3, 2002).” Honeywell has taken a pioneering role in dealing with these issues and developed Nova.

Nova wire integrity program is “an integrated and portable system designed and developed by Honeywell to test and identify faulty wiring and connections in older aircraft (Shavarini, 2002).” Nova system is based on advanced modeling, diagnostics software, and maintenance planning from Qualtech Systems, which is collaborating with Honeywell in this endeavor. The Remote Diagnostics Server (RDS) from Qualtech, which was mainly developed for NASA, is a fundamental element in the Nova system.

Nova performs wiring system modeling, failure analysis, trend monitoring, prognostics, diagnostic analysis, and data logging of test results and automatic test generation. The software makes it possible for technicians to optimize their wiring test and maintenance strategy within their current maintenance processes.

According to Kevin Cavanaugh, Qualtech’s chief operating officer, “users can upload test data to the remote diagnostics server over the internet or other network. The data is then automatically processed through the intelligent model-based reasoning in seconds, dynamically generating an HTML web page display of the resulting diagnostics (Shavarini p.4, 2002).”The remote diagnostics server makes it possible for intelligent dynamic tests, diagnostics and maintenance procedures to be launched, thereby verifying the operational integrity of the wiring

system. In addition, the software is web based which allows for integration with the supply chain system, logistics databases, and computerized maintenance management systems.

Nova wire integrity program employs intelligent telemaintenance to electronically test and identify faulty wiring and connections in aircraft. The telemaintenance system not only analyzes data streams and embedded sensors in networked subsystems but also troubleshoots and identifies failures automatically in real time. Additionally, it provides ongoing health checks and locates areas that might turn out to be problematic before they happen (Shavarini, 2002).

Use of real time fault detection and isolation solutions are fundamental to faster, less expensive, and more effective operation of complex systems. Nova system reduces the likelihood of operational failures and disasters resulting from a sudden failure, thereby improving system safety and availability (Shavarini, 2002).

Gau states, “Qualtech’s software along with other powerful features within Nova empowers operators to diagnose and locate most faults within the wiring system. Fully integrated Nova can test 5, 000 wires in a minute and detect faults (shorts, open, insulation wear) and their location in the aircraft to within 1 centimeter (0.39 inches) (Shavarini p.5, 2002).” Maintenance personnel have several unit options to choose from, including how the unit is connected to the aircraft. The smallest unit weighs 70 pounds and costs approximately \$100,000 and the larger units can weigh thousands of pounds and cost up to \$1 million. According to Gau, irrespective of the size of the system, each unit is designed to define faults within centimeters in Honeywell’s laboratory or one to two feet within a hangar environment.

Some of the benefits of Nova system are in the following areas:

1. Manufacturing, where it can help ensure quality standards with building and installation of wire bundles in aircrafts.

2. Flight line maintenance to quickly resolve specific wires with faults and validate their location and criticality.
3. Heavy maintenance where tests can be performed during scheduled maintenance to monitor the wire integrity of the aircraft.
4. Improved operational safety- wire failures and their criticality are quickly and automatically identified and possibly alleviated.
5. Improved availability – because most of the system diagnosis is done online, and in real time, downtime for troubleshooting and life cycle costs is minimized.
6. Improved confidence in system serviceability – the self testing and monitoring capabilities of the remote diagnostics server continuously and accurately monitor the health of the system with a high degree of certainty.
7. Automated testing and data archiving.
8. Reductions in staff required for testing aircraft wiring system.

Honeywell claims, “ about 3-10% of all maintenance hours are spent on wiring and estimates that manual troubleshooting of an average narrow body aircraft could be reduced by 88% (from \$87,040 to \$10,880) over a period of four years (Rosenberg, 2001). The end result is effective preventive maintenance; locating wiring faults and preventing accidents, while cutting down on operational costs.

Figure 20 illustrates troubleshooting time costs for an average narrow body aircraft over four years (Overview of Nova, 2002).

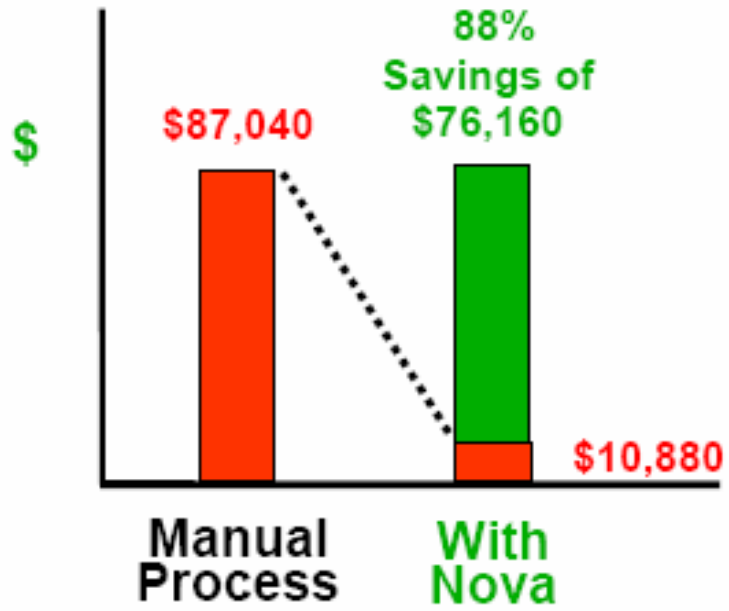



Figure 20. Troubleshooting Time Costs for an Average Narrow Body Aircraft (Overview of Nova, 2002).

Table 7 outlines Advanced Nova Test Capabilities (Overview of Nova, 2002).

Table 7

Advanced Nova Test Capabilities (Overview of Nova, 2002)



		Advanced Nova Test Capabilities								
ANOMALIES		Existing Visual Inspection	TDR	Continuity	Isolation	Hi-Pot (DWV)	Capacitance Measurement	Resistance Measurement	Conductive Fluid Scanning	WIDAS Test
Shorts		X		X			X			
Opens		X	X			X				
Damaged Insulation	S	S			X	X		X		
Damaged Conductor	S	S								
Damaged Shields	S	S								
Corroded Connector		S	S	S						
Fault Location/Interpretation	S	X				X	X	X		
Life Limit										X
Components/Configuration Check			X	X		X	X			

Available Q2/2002 Available Now

S = Some capabilities

Significant improvement in wiring integrity can only be accomplished by moving from a reactive to a proactive wiring system maintenance approach. Development and implementation of new wiring inspection technologies will result in substantial maintenance cost savings, reduction in in-flight electrical fires, and enhance passenger and crew safety.

CHAPTER 6

ANALYSIS OF THE CONVENTIONAL AND TRANSITION

WIRE MAINTENANCE METHODS

In July 1998, the Federal Aviation Administration (FAA) announced their Aging Transport Non-Structural Plan. The details of the plan are highlighted in the following statement concerning current wiring maintenance practice:

“Current maintenance practices do not adequately address wiring components (wire, wire bundles, connectors, clamps, grounds, shielding). Inspection criteria is too general. Typically a zonal inspection task card would say to perform a general visual inspection. Important details pertaining to unacceptable conditions are lacking. Under current maintenance inspection practices, wire is inspected visually. Inspection of individual wire in bundles and connectors is not practical because aged wire is stiff and dismantling of bundles and connectors may introduce safety hazards. Wiring inside conduits is not inspectable by visual means. The current presentation and arrangement of standard practices make it difficult for an aircraft maintenance technician to locate and extract the pertinent and applicable data necessary to effect satisfactory repairs. Under current maintenance philosophy, wire in conduits is not inspected. A review of incident reports and maintenance records indicate current reporting system lacks visibility for wiring making it difficult to assess aging trends (FAA Aging Transport Non-Structural Systems Plan, p.5 1998).

The above paragraph clearly shows that visual inspection, which is the current maintenance practice for both commercial and military aircraft, has intrinsic disadvantages and is not the most effective method of wiring maintenance. Current inspection and troubleshooting are often limited to visual identification and verification with a multimeter.

The conventional wire maintenance methods used in the aviation industry include the handheld multimeter, time domain, frequency domain, and standing wave reflectometer.

Handheld Multimeter

By far the most commonly used piece of equipment in aircraft wiring maintenance is the handheld multimeter. A handheld multimeter is typically used in aircraft wire testing to locate wire open or short circuits. A handheld multimeter is limited in its abilities to measure certain aspects of wiring anomalies. For example, a multi-strand wire could be hanging by a few strands and pass electrically with the multimeter on the ground. That same wire may be cause for failure when the aircraft is in the air under load conditions (D'Angelo et al., 2000).

Time Domain Reflectometer

A fully automated time domain reflectometer offers a wide range of fault diagnostics and prognostics with exact location and interpretation of wire faults in aircrafts. Computer compatibility allows information stored in the time domain reflectometer to be uploaded to a computer waveform. This ensures waveforms can be adjusted or analyzed on the computer while the time domain reflectometer carries out other tests. This storage features allows for data retrieval and archiving. Impedance changes along the length of the aircraft wire will identify if the wire fault is an open or short circuit.

Frequency Domain Reflectometer

A frequency domain reflectometer analyzes the reflected sine waves to determine if the impedance changes are as a result of an open or short circuit. A frequency domain reflectometer is an efficient and safe method for detecting impedance changes in aircraft wiring because it consumes less power than a time domain reflectometer.

Standing Wave Reflectometer

A standing wave reflectometer is best described as an impedance based cable tester. The standing wave reflectometer is considered to be non-intrusive and highly accurate in fault detection. This is because it can provide the distance to discontinuity in an electrical cable without removal of the cable from the circuitry to which it is connected.

Many of the conventional maintenance approaches are reactive and only address wiring when a failure cannot be resolved. Added onto this, these conventional maintenance practices lack the effectiveness to manage and maintain the aircraft wiring anomalies prior to flight. More proactive methods are needed so that aircraft wiring failures can be anticipated and wiring systems can be replaced during scheduled maintenance activities.

Smart Wiring

Smart wiring technology provides diagnostic and prognostic capabilities as well as documentation of the current condition of an aircraft wiring system on a Bureau Number (BuNo) basis. This health tracking system is intended to be proactive in repairing wire failures by addressing them during planned maintenance (Nieto, 2000). Smart wiring and smart connectors have the sensors and embedded processing that facilitates early inspection and detection of short and open conditions in the aircraft wiring without the dangers caused by high voltages used in other testing methods (Blemel & Furse, 2001).

Smart wiring system components are positioned in-situ; this enables them to detect not only the occurrence of the problem but also the causes of the problems, consequently creating a proactive environment that senses leading indicators of the problems (Blemel & Furse, 2001). Implementing a smart wiring system into existing platforms basically implies rewiring the aircraft which would be highly intrusive, labor intensive, time consuming, and very costly

(Nieto, 2000). Despite this, given the benefits that would result from installing a smart wire system, the high costs involved would pay off in the long run.

Arc Fault Circuit Breakers

The Federal Aviation Administration (FAA) approximates that “the deterioration of electrical wiring in aging aircraft including cracked insulation, the contamination of wire bundles, normal maintenance wear and damage and thermal cycling-all contribute to the potential for a 6,000 degrees Fahrenheit arcing event that cannot be detected by standard aviation circuit breakers (Parsons, 2003)”. These undetected incidences could eventually lead to a disastrous electrical fire. Electrical arcing is a major cause of in-flight electrical fire in the aviation industry. The Federal Aviation Administration (FAA), National Transportation Safety Board (NTSB), and the Transportation Safety Board of Canada investigations believe that electrical systems arcing contributed to the crash of TWA Flight 800 in 1996 and Swiss Air Flight 111 in 1998.

An arc fault circuit breaker is designed to react faster to the presence of arcing and shutdown the electrical load before a fire can result, thereby minimizing the number of electrical fires in aircraft. A comparison between arc fault circuit breakers and smart wire systems show that arc fault circuit breakers are less intrusive to install and address a key safety concern of arcing in power distribution systems. Arc fault circuit breakers effectively manage aircraft wiring systems by detecting and preventing electrical arcing before it damages the surrounding wiring, other equipment and the aircraft structure. In addition, it significantly cuts down aircraft inspection and maintenance costs.

Nova

Nova wire integrity program is “an efficient, proactive and comprehensive aircraft wire maintenance system (Overview of Nova, 2002)”. Nova program is specialized for each user.

Honeywell examines each user's troubleshooting data and verifies which systems failed most frequently. This is then followed by Honeywell's six sigma approach which is as follows (Overview of Nova, 2002).

1. Define the scope of the problem- aircraft type and location (1-2 days).
2. Measure the amplitude of the problem- data mining maintenance records and refine criteria based on operational profile (1-2 weeks).
3. Analyze the data- most frequent systems and critical systems isolated (1-2 weeks).
4. Implement the solution- model the systems in Nova's software, design and order adapters, select customize, and order Nova's hardware and software package and finally train users (3-6 weeks).
5. Control and monitor results by the aircraft (ongoing process).

Because Honeywell loads all of the probability and systems data into the unit, a technician can look at the probability of failure while inspecting the aircraft wiring system. This proactive approach can help operators and maintenance shops schedule maintenance ahead of time, instead of waiting for a problem to arise and cause schedule interruptions (Overview of Nova, 2002).

Conventional wire maintenance methods generally require disconnecting both ends of the wire to perform tests conversely; Nova system does not require wire disconnection and it locates open and short circuits with a high degree of accuracy from one end of the wire.

Smart wire systems and arc fault circuit breakers usually perform one or two tests on the aircraft wiring system. On the contrary, Nova system performs twenty different tests simultaneously on a single wire. In addition, Nova quickly carries out multiple tests across multiple bundles and multiple wires, thereby allowing it to continuously and accurately monitor the electrical system of the aircraft. Nova system inspects aircraft wiring on an ongoing basis,

hence wiring anomalies can be automatically identified and possibly alleviated before they affect the overall wire integrity system and cause accidents. Nova system signifies a remarkable and innovative solution to diagnosing aircraft wiring problems and proactively managing the health of aircraft wiring systems. Unfortunately, according to Jeff Rollins of Honeywell, “industry conditions have made it clear that the timing of Nova was not matched to the current environment.” As a result of this, the Nova program has been shelved until market conditions are favorable.

Table 8 shows a summary of the analysis between conventional and transition wire maintenance programs.

Table 8

Analysis Between Conventional and Transition Wire Maintenance Methods

Maintenance Method	Wire Fault Detection Capabilities	Data Retrieval & Archiving	Wire Disconnect At both ends	Early detection & Identification of Wire Failures
Handheld Multimeter	Detects electrical shorts & opens	No	Yes	No
Time Domain Reflectometer	Detects electrical shorts & opens	Yes	Yes	No
Frequency Domain Reflectometer	Detects electrical shorts & opens	No	Yes	No
Standing Wave Reflectometer	Detects electrical shorts & opens	Yes	Yes	No
Smart Wiring	Detects electrical shorts, opens, frayed condition & intermittent connections	Yes	No	Yes
Arc Fault Circuit Breakers	Detects electrical arcing & intermittent short circuiting	No	No	Yes
Nova	Detects electrical shorts, opens, damaged insulation, conductor, shields & connectors	Yes	No	Yes

Conventional wire maintenance practices require disconnecting the aircraft wiring at both ends to perform electrical test which inherently increases the risk to the aircraft wiring through wear and tear on the connectors, and the wiring itself and possible damage to the nearby structures. These programs are also reactive in nature and only address wiring when the failure has already happened. In contrast, transition maintenance programs do not require disconnection at both ends of the wire to perform the electrical tests. In addition, they facilitate inspection and early detection of wire failures before they affect electrical system operation. These transition programs depict a proactive wire maintenance approach designed to improve the overall wire system integrity and minimize maintenance costs, time and enhance flight safety.

CHAPTER 7

CONCLUSIONS AND RECOMMENDATIONS

Aging wiring presents a dangerous and complex problem for the commercial and military aviation. Recent air disasters in both the commercial and military aviation clearly point out that the effects of aging on aircraft wiring can be catastrophic. As aircraft continue to be used beyond their intended life, more problems due to aging become more evident.

Aging aircraft wiring poses a problem for aircraft maintenance. This is due to the tremendous amount of time spent on troubleshooting wiring to fix repairs and high maintenance costs. In addition, current maintenance practices do not effectively manage the aging wiring problem. Aviation technicians need to be provided with the correct maintenance tools and practices to combat the aging wiring dilemma. This thesis provides the conclusions and recommendations for addressing the aging wiring problem.

Conclusions

Aircraft Wiring Ages and Deteriorates Over Time

All aircraft electrical wiring systems are liable to aging during their normal service life. Aging results in the progressive deterioration of physical properties and performance of wiring systems with the passage of time. Wiring is susceptible to more rapid deterioration with age in areas of high contamination, vibration, temperature variation, and corrosion and where it is attached to movable or removable parts. The aging process can be significantly accelerated by frequent handling or maintenance actions on or near the wiring systems. As aircraft continue to fly for long periods of time, the occurrence of wire degradation gets higher consequently, increasing the number of wire failures.

Aging Wiring Severely Impacts Aircraft Safety

The Federal Aviation Administration (FAA) and the National Transportation Safety Board (NTSB) have reported hundreds of potential hazardous incidents of smoke and electrical problems in aircraft cabins and cockpits. Table 1 lists a few examples of incidents involving electrical problems. Aircraft accident investigators have attributed Swiss Air Flight 111 in 1998 and TWA Flight 800 in 1996 to fires caused by aged and damaged electrical wiring. In 2000, a recent review of system discrepancy reports showed that commercial aircraft were experiencing an average of three smoke and fire events per day. The data pointed out that approximately a thousand of these events happening per year are directly linked to electrical anomalies. A Navy study of NAVAIR found in-flight electrical fires related to wiring occurring at a rate of approximately two per month. This study found that the Navy was spending about 1.8 million man-hours per year troubleshooting and repairing wiring systems. These studies have made clear that aging wiring is a serious problem that can lead to loss of critical aircraft systems, onboard fires, and ultimately loss of an aircraft.

Current Maintenance Programs do Not Effectively Address Aircraft Wiring

As stated by the FAA's Aging Non-Structural Plan dated July 1998, many of the current maintenance practices are reactive and only address the wiring system failure after it occurs. Table 4 shows how frequent visual inspection is used as the primary method to detect wire failures. Visual inspection is primarily used today to inspect the condition of both commercial and military aircraft wiring and to control aging mechanisms and damage resulting from normal operation and maintenance.

NTSB 194-5 states that visual inspection only detects 29-39% of wire defects and is considered to be time consuming. Visual inspection limits the degree to which aircraft wiring can

be inspected effectively without increasing the risk of damaging the wiring during inspection. This is because most wires are difficult or impossible to see due to their location within the aircraft or position within a large bundle of wires. For that reason, more proactive maintenance methods are needed so that aircraft wiring failures can be inspected and detected before they affect the electrical system operation.

Recommendations

Incorporate Proactive Wire Maintenance Programs

Smart wire systems, arc fault circuit breakers, and Nova systems are examples of new transition technologies that need to be incorporated to effectively manage aging wiring systems in aircrafts. Development and implementation of these programs will bring about substantial maintenance cost savings, and reduction in aircraft electrical fires while improving the safety and reliability of the aircraft we fly.

Enhance Collaboration among Industry, Academia and the Government

Currently, there is no common database across the industry, academia, and the government that provides wiring failure histories. In addition, no common method exists for circulating data on wiring system failures. Data documentation will help evaluate current practices and set priorities for research initiatives based on cost, time and overall risk.

Improve the Management and Functionality of Wire Systems

Standardized tools are needed to develop and track changes in the configuration of wire systems. These tools should be capable of alerting the technicians of conditions that may cause system failures.

Support Training

Training is key in reducing the increasing number of aircraft wiring problems and minimizing the potential for catastrophe. More intensive and detailed training is needed in the installation, inspection, and maintenance of wire systems.

REFERENCES

- Aircraft Wiring Practices (2002). Retrieved June 23, 2004, from http://www.academy.jccbi.gov/AIRDL/WiringCourse/JA-w-All_files/frame.htm
- Arnason, P. (2001). CTMA wiring diagnostics initiative. *CTMA Symposium*. Patuxent River, MD.
- Arnason, P., Field, S., & Furse, C. (2001, September). *Smart wire technology for aircraft applications*. Paper at the Fifth Joint NASA/FAA/DoD Conference on Aging Aircraft, Orlando, FL.
- B & K Precision Corporation (2004). Retrieved June 23, 2004, from http://www.bkprecision.com/www/NP_quick_search.asp?page=1&st=multimeters&style=&so=&cat=
- Bicotest (2002). High specification cable fault locator. Retrieved June 23, 2004, from <http://www.bicotest.co.uk/productpages/t631.html>
- Blemel, G., & Blemel, A. (2000, June). *Smart wiring prognostic health management*. JAWSSS Conference, San Antonio, TX.
- Blemel, K. (2000). Sentient systems for enhanced safety and reduced costs. Retrieved June 23, 2004, from <http://www.dawnbreaker.com/virtual2004/briefings/MSI-Connector.pdf>
- Blemel, K., & Furse, C. (2001, March). Applications of microsystems and signal processing for wiring integrity monitoring. *IEEE Aerospace Symposium*. Big Sky, Montana.
- Brighton Electronics (2002). Retrieved June 23, 2004, from <http://www.brighton-electronics.com/multimeters.htm>
- Brown, M., & Gau, F. (2001, September). *Wire integrity programs and aging aircraft sustainment*. Paper at the Fifth Joint NASA/FAA/DoD Conference on Aging Aircraft,

Orlando, FL.

Chung, Y., Dangol, R., Furse, C., Mabey, G., Nielsen, M., & Woodward, R. (2003).

Transactions on electromagnetic compatibility. *IEEE Spectrum* 45 (2), 239-240.

Commercial Technology Transition Officer (2003). *Automatic wiring Analysis*.

Retrieved June 23, 2004, from http://www.onr.navy.mil/ctto/auto_wiring.asp

D'Angelo, J., Decker, A., Dicks, D., Johnson, D., & White, E. (2001, September). *Wiring*

system diagnostic techniques for legacy aircraft. Paper at the Fifth Joint

NASA/FAA/DoD Conference on Aging Aircraft, Orlando, FL.

D'Angelo, J., Dicks, D., Slenski, G., (2001, September). *Wire integrity analysis of air force*

weapon systems. Paper at the Fifth Joint NASA/FAA/DoD Conference on Aging

Aircraft, Orlando, FL.

Federal Aviation Administration (1976). *Advisory Circular AC 65-15A*. Retrieved June

23, 2004, from,

http://www.airweb.faa.gov/Regulatory_and_Guidance_Library/rgAdvisoryCircular.nsf/0/66AB237BAF7184A0862569F1005F7733?OpenDocument&Highlight=ac%2065

Federal Aviation Administration (1998). *Advisory Circular AC 43.13-1b*. Retrieved

June 23, 2004, from

http://www.airweb.faa.gov/Regulatory_and_Guidance_Library/rgAdvisoryCircular.nsf/0/99C827DB9BAAC81B86256B4500596C4E?OpenDocument&Highlight=ac%2043.13-1b

Federal Aviation Administration (1998, July). *Aging transport non-structural systems plan*.

Retrieved June 23, 2004, from

http://www.faa.gov/certification/aircraft/aging_transport_plan.pdf

Fiorino, F. (2003, April 14). Air transport. *Aviation Week & Space Technology*, 158 (15), 62.

Fluke Corporation (2004). Retrieved June 23, 2004, from

<http://www.fluke.com/products/sections.asp?AGID=6&SID=9>

Furse, C. (2003). U.S. Patent No. 0030125893. Washington, DC: U.S. Patent and Trademark Office.

Furse, C., & Haupt, R. (2001). Down to the wire. *IEEE Spectrum* 38 (2), 34-39.

Furse, C., & Niles, K. (2004). U.S. Patent No. 0040015311. Washington, DC: U.S. Patent and Trademark Office.

Furse, C., & Waddoups, B. (2001). Detection of chafed insulation in aging aircraft wiring. *IEEE Antennas & Propagation Symposium*. Boston, MA.

Furse, C., & Woodward, R. (2003). U.S. Patent No. 0030222654. Washington, DC: US Patent and Trademark Office.

GlobalSpec, n.d. Retrieved June 23, 2004, from

<http://test->

[equipment.globalspec.com/LearnMore/Labware_Test_Measurement/Multimeters_Electrical_Test_Meters/Analog_Multimeters](http://test-equipment.globalspec.com/LearnMore/Labware_Test_Measurement/Multimeters_Electrical_Test_Meters/Analog_Multimeters)

<http://test->

[equipment.globalspec.com/LearnMore/Labware_Test_Measurement/Multimeters_Electrical_Test_Meters/Digital_Multimeters](http://test-equipment.globalspec.com/LearnMore/Labware_Test_Measurement/Multimeters_Electrical_Test_Meters/Digital_Multimeters)

Hast, B., & Madaras, E. (2001). *Inspecting aged aircraft wiring with portable labview-driven ultrasonic evaluation systems*. Retrieved June 23, 2004, from

http://www.banigaru.com/application/research_2001.pdf

Aging transport systems rulemaking advisory committee (1999). Retrieved June 23, 2004, from

<http://www.mitrecaasd.org/atrac/>

Kenwood TMI Corporation (2001). Retrieved June 23, 2004

<http://www.kenwoodtmi.co.jp/producte/index.html>

Kuzniar, J., & Slenski, G. (2002, September). *Aircraft wiring system integrity initiatives- A government and industry partnership*. Paper at the Sixth Joint NASA/FAA/DoD Conference on Aging Aircraft, San Francisco, CA.

Lane, N. (2000, November). *Review of federal programs for wire system safety*. National Science And Technology Council, Committee on Technology. Wire System Safety Interagency Working Group.

Larsen, W., & Teal, C. (2002, September). *Technology update- wiring prognostic tools*. Paper at the Sixth Joint NASA/FAA/DoD Conference on Aging Aircraft, San Francisco, CA.

Maher, E. (2004, March). Finding no faults. *Aviation Today*, 3-5.

Milliman, J. (2001, April-June). Air wing tool box: tackling an aging-aircraft wiring risk. *Naval Safety Center Mechanic issues*, 1-3.

National Transportation Safety Board (2000). *TWA Final Report No.NTSB/AAR-00/03*
Retrieved June 23, 2004, from <http://www.nts.gov/Publictn/2000/AAR0003.pdf>

Neito, M. (2000). *Naval aviation aging ailing: prognostic and diagnostic solutions*.
Master's thesis, Naval Postgraduate School, Monterey, CA.

Overview of Nova (2002). Retrieved June 23, 2004, from

http://www.mitrecaasd.org/atrac/meeting_minutes/2002/2002_04_Honeywell_Overview_of_Nova.pdf

Federal Aviation Administration (2001, October). *Aging Electrical Systems Research*

- Program, 14*. Retrieved June 23, 2004, from
http://www.mitrecaasd.org/atrac/meeting_minutes/2001/2001_10_brief.pdf
- Parker, G. (n.d.) Cable and cable fault locating - Part 3 *Electrical Line Magazine*.
- Parsons, P. (2003, January). Eaton awarded additional funding to develop electrical wiring arcing Protection circuit breakers for civil, military aircraft. *Aerospace News*, 1147.
- Paterson, A. (2003). *Aircraft electrical wire types*. Retrieved June 23, 2004, from
http://www.vision.net.au/~apaterson/aviation/wire_types.htm
- Phillips, J. (2004, February). New circuit breaker halts arc fault. *Military Publication*, 1-5.
- Riserbond (2004). Retrieved June 23, 2004, from
<http://www.riserbond.com/PRODUCTS/products.html>
- Rosenberg, B. (2001). Aircraft wire integrity program employs intelligent telemaintenance. *Aviation Week & Space Technology*, 155 (24) 82-83.
- Sadeghi, M. (2002, September). *Federal Aviation Administration aging systems program*. Paper At The Sixth Joint NASA/FAA/DoD Conference on Aging Aircraft, San Francisco, CA.
- Shavarini, H. (2002, May-June). Intelligent telemaintenance wire harness integrity tester. *wiring harness news*. Retrieved June 23, 2004, from
http://www.wiringharnessnews.com/Articles/2002/INTELL_1/intell_1.HTM
- Smith, C., (2000, December). Transport aircraft intrusive inspection project, an analysis of the wire installations of six decommissioned aircraft. Retrieved June 23, 2004, from
http://www.mitrecaasd.org/atrac/intrusive/Chapter_1.pdf
http://www.mitrecaasd.org/atrac/intrusive/Chapter_2.pdf
http://www.mitrecaasd.org/atrac/intrusive/Chapter_3.pdf
http://www.mitrecaasd.org/atrac/intrusive/Chapter_4.pdf

http://www.mitrecaasd.org/atrac/intrusive/Chapter_6.pdf

Smith, C. (2002). Special issue on aging aircraft. *Office of Aviation Research*, 1 (4) 9-10.

Tambouratzis, V. (2001). *Aging aircraft wiring: A proactive management methodology*.

Master's Thesis, Naval Postgraduate School, Monterey, CA.

Tequipment.net (2004) <http://www.tequipment.net/BK5380.asp>,

<http://www.tequipment.net/BK114B.asp>

Test Products International (2004). Retrieved June 23, 2004, from

<http://www.testproductsintl.com/digmm.html>

TWA Flight 800: The Reconstruction (1999). Retrieved June 23, 2004, from

<http://www.whatreallyhappened.com/RANCHO/CRASH/TWA/RECON.html>

White House Commission on Aviation Safety and Security (1997). *Gore Commission*

Final Report. Retrieved June 23, 2004, from

<http://www.fas.org/irp/threat/212fin~1.html>

APPENDICES

Appendix A

Acronyms

1. AC – ADVISORY CIRCULAR
2. AFCB – ARC FAULT CIRCUIT BREAKER
3. AFRL – AIR FORCE RESEARCH LABORATORY
4. ASIC – APPLICATION SPECIFIC INTEGRATED CIRCUIT
5. ATSRAC – AGING TRANSPORT SYSTEMS RULEMAKING ADVISORY
COMMITTEE
6. BuNo – BUREAU NUMBER
7. CE – CONFORMANCE EUROPEAN
8. CTMA – COMMERCIAL TECHNOLOGIES FOR MAINTENANCE ACTIVITIES
9. CWT – CENTER WING FUEL TANK
10. DC – DIRECT CURRENT
11. DMM – DIGITAL MULTIMETER
12. DOD – DEPARTMENT OF DEFENSE
13. FAA – FEDERAL AVIATION ADMINISTRATION
14. FDR – FREQUENCY DOMAIN REFLECTOMETER
15. FS – FUSELAGE STATION
16. HIRF – HIGH INTENSITY RADIATED FIELD
17. IPT – INTEGRATED PROCESS TEAM
18. ISO – INTERNATIONAL ORGANIZATION FOR STANDARDIZATION
19. JSF – JOINT STRIKE FIGHTER

20. LCD – LIQUID CRYSTAL DISPLAY
21. MEMS – MICRO MACHINED ELECTROMECHANICAL SYSTEMS
22. MSI – MANAGEMENT SCIENCES INCORPORATED
23. NAVAIR – NAVAL AIR SYSTEMS COMMAND
24. NDT – NONDESTRUCTIVE TESTING
25. NTSB – NATIONAL TRANSPORTATION SAFETY BOARD
26. OAM – ORIGINAL AIRCRAFT MANUFACTURER
27. ONR – OFFICE OF NAVAL RESEARCH
28. RDS – REMOTE DIAGNOSTIC SERVER
29. RF – RADIO FREQUENCY
30. SAE ARP – SOCIETY OF AUTOMOTIVE ENGINEERS AEROSPACE
RECOMMENDED PRACTICE
31. SFAR – SPECIAL FEDERAL AVIATION REGULATION
32. SWAMP – SEVERE WIND AND MOISTURE PROBLEMS
33. SWR – STANDING WAVE REFLECTOMETER
34. TDR – TIME DOMAIN REFLECTOMETRY
35. TKT – TEFLON KAPTON TEFLON
36. TPI – TEST PRODUCTS INTERNATIONAL
37. TWA – TRANS WORLD AIRLINES
38. WHCSS – WHITE HOUSE COMMISSION ON AVIATION SAFETY AND
SECURITY
39. WSSIWG – WIRE SYSTEM SAFETY INTERAGENCY WORKING GROUP

Appendix B

Glossary

1. DIAGNOSTICS – Identification by examination or analysis.
2. IMPEDANCE – A measure of the total opposition to current flow in an alternating current circuit.
3. PROGNOSTICS – Prediction on the basis of present indications.
4. ARC FAULT - An unintentional electrical discharge characterized by low and erratic current that may ignite combustible materials.
5. STANDING WAVE REFLECTOMETER – A non-intrusive impedance-based cable tester.
6. DMM CAT I – Signal level, equipment or parts of equipment, telecommunication, electronics
7. DMM CAT II – Local level mains, appliances, portable equipment.
8. DMM CAT III – Distribution level mains, fixed installation.
9. DMM CAT IV – Primary supply level; service drop to building (outside).
10. DMM EN 55011 – Radiated emissions standard.
11. IEC 1010-1 –Specifies categories of overvoltage based on the distance from the power source and the natural damping of transient energy that occurs in an electrical distribution system.
12. AC 25.10 (1987) – Guidance for Installation of Miscellaneous Nonrequired Electrical Equipment
13. AC 25-16 (1991) – Electrical Fault and Fire Prevention and Protection

14. AC 43.13-1b (1998) – Acceptable Methods, Techniques and Practices – Aircraft
Inspection and Repair

Appendix C

Aircraft Wire Table

The following table relates to general purpose aircraft electrical wire. All transport jet and turboprop aircraft have a mixture of the following different wire types installed in them. The wire types listed in the table relate to the predominant type for each aircraft. It would appear that even aircraft manufacturers themselves are not completely sure as to what wire is installed in individual aircraft as their attitude towards wire in the past has been "wire is wire".

NOTE 1: Wire is listed in the table by date of introduction into aircraft, with the oldest wire typed listed at the top.

NOTE 2: Colors code:

UNSAFE WIRE
SAFE WIRE

WIRE TYPE	DESCRIPTION	AIRCRAFT INSTALLED IN (some)
PVC/Nylon (Polyvinyl-Chloride) Introduced 1950s Specification No: 5086	<p style="text-align: center;">Fails Far 25</p> Weight 6.8 lbs. per 1,000 ft (Heaviest and thickest) <u>Rated temperature:</u> 105°C Flammable - burns readily creating copious amounts of thick, toxic smoke rendering it virtually impossible for pilots to see their flight instruments or breathe. (e.g. Valujet 592) Insulation when burning turns to hydrochloric acid when exposed to water. <u>Outgasses</u> onto electrical & electronic contacts Soft - Susceptible to chafing Susceptible to <u>aging</u> and becomes ...? Banned by US Air Force	Installed in Early DC-9s up until 1979 (e.g. Valujet 592) Early B727s up until 1976 Early B737s up until 1976 <input type="checkbox"/> Still used as general purpose replacement wire by sections of the aviation industry.

	<p>US Air Force had 800 autopilot anomalies due to defective PVC in a 6 month study in --</p> <p>Still used as general purpose replacement wire.</p> <p>Implicated in ValuJet Flight 592 DC9 which crashed into the Florida Everglades on 11 May 1996</p> <p>A Dangerous wire</p>	
<p>Kynar</p> <p>Introduced in 1964</p> <p>Specification number: 81044/9</p>	<p>Fails Far 25</p> <p>Thickness: 15 microns</p> <p>Weight 5.5 lbs per 1,000 ft.</p> <p>Rated Temperature: 150°C (fails temperature spec)</p> <p>poor fluid resistance</p> <p>No longer used</p>	<p>Installed in</p> <p>DC9s from 1970 until 1976</p>
<p>Kapton</p> <p>(complex aromatic polyimide)</p> <p>Introduced 1966</p> <p>Specification Numbers: 81381/11</p>	<p>Fails Far 25</p> <p>Thickness: 8.4 microns (Very thin)</p> <p>Weight: 4.6 lbs per 1,000 ft (Very light weight)</p> <p>Rated temperature: 200°C</p> <p>Explodes and burns fiercely at arc over (i.e. short circuit) due to the production of free hydrogen, severely damaging surrounding wires and igniting surrounding structure. ¹</p> <p>High ignition temperature to start burning (usually associated with an electrical short circuit 5000°C), but when it does finally ignite it burns very fiercely (explodes) creating virtually no smoke.</p>	<p>Installed in</p> <p>Airbus A310 (all)</p> <p>Airbus A320 (currently) ²</p> <p>Airbus A330 (currently)</p> <p>Airbus A340 (currently)</p> <p>B727 (after 1979, EB)</p> <p>B737 (after 1979 to 1990)</p> <p>B747-400 (some from 1989 - 1991)</p> <p>B757 (up until 1990)</p> <p>B767 (up until 1991)</p> <p>DC-10</p> <p>MD-8x (all)</p> <p>MD-11 (up until early 1992)</p> <p>A300 -600 (with Teflon top-coat)</p> <p>L-1011 Tristar</p> <p>Concorde SST</p>

	<p>Fumes are clear and fairly benign</p> <p>Susceptible to wet and dry Arc Tracking.</p> <p>Susceptible to aging in that it dries out forming hairline cracks which can lead to micro current leakage (i.e. electrical 'ticking' faults) which in turn can eventually culminate in an explosive arc tracking event.(short circuit) ¹</p> <p>Stiffness (straight line memory) makes it prone to vibration chafing, (rubbing) and stressed by bending.</p> <p>Abrasive to other wires. (due to its hardness)</p> <p>Hygroscopic (i.e. absorbs water) rendering it susceptible to wet arc tracking.</p> <p>Installation difficulties (difficult to strip and mark)</p> <p>Banned by</p> <ul style="list-style-type: none"> * US Air Force * US Navy * Canadian military * Boeing in 1992 * Bombadier? <p>VERY DANGEROUS WIRE</p>	<p>B-707 (but not according to EB)</p> <p>Dassault Mercure</p> <p>CL 600 Series (but <u>not</u> RJ/CL604 or Global Express (Challenger)</p> <p>Shorts SD-330</p> <p>Gulfstream G-II, G-III</p> <p>HS125-700</p> <p>Bell 212, 214</p> <p>Sikorsky S-61, S-70B, S-76</p> <p>Westland 606</p> <p>Plus 31 military types such as P-3, C130, F-14, F-18, Hawkeye, etc</p> <p><input type="checkbox"/> Still used by AIRBUS in A319, A320, A330, A340 (see footnote 2)</p>
<p>Teflon (Polytetrafluoroethylene)</p> <p>Introduced in 1969</p> <p>Specification Numbers: 22759/11</p>	<p>Fails Far 25</p> <p>Thickness: 10 microns</p> <p>Weight 5.43 lbs/1,000 ft.</p> <p>Rated temperature: 200°C</p> <p>Longitudinal splitting problem due to manufacturing process.</p> <p>Susceptible to cold-flow (creeping of conductor).</p>	<p>Installed in B747</p>

	<p>Type of insulation found as ignition source on Apollo 13</p> <p>Type of insulation found split in TWA 800-fuel tank wires [Fuel Quantity Indicating System] (FQIS)</p> <p>Banned by major manufacturers in 1983</p>	
<p>Poly-X (alkane-imide) an Aliphatic Polyimide Introduced in 1970 Specification Numbers: 81044/16-29</p>	<p>Fails Far 25</p> <p>The first exotic blend of insulation (due to oil embargo)</p> <p>Thickness: 10 microns</p> <p>Weight: 4.7 lbs. per 1,000 ft (Light weight)</p> <p>Rated temperature: 150°C</p> <p>Susceptible to solvents</p> <p>Susceptible to <u>radial cracking</u>. Projected service life 60,000 hrs/but circumferential cracks found after 2000 hrs by US Navy.</p> <p>Susceptible to aging. Banned by US Navy in 1978 due to premature aging of insulation after 4000 hrs</p> <p>Brittle. Due to brittleness, 1" bare spots not uncommon.</p> <p>Susceptible to chafing.</p> <p>Fails FAR 25 (airworthiness testing standards)</p> <p>Caused 323 USN F-14s to be re-wired</p> <p>Banned by US Navy.</p> <p>No longer used in civilian aircraft</p>	<p>Installed in</p> <p>Early 747s (e.g. TWA 800)</p> <p>Early DC-10s</p>
<p>Stilan Introduced 1972</p>	<p>Fails Far 25</p> <p>Thickness: 10 microns</p>	<p>Installed in</p> <p>B-747s built in mid-to-late</p>

<p>Specification Numbers: 81044/20</p>	<p>Weight 4.7 lbs. per 1,000 ft (Light weight) Rated Temperature: 150°C Insulation breaks down in hydraulic and de-icing fluid Microscopic crazing problem seen under microscope Cracks under stress Found to arc over Susceptible to spurious signal generation (EMI hazard) Absorbs water (i.e. hygroscopic) No longer used</p>	<p>1970s DC-10s built in mid-to-late 1970s</p>
<p>Tefzel (ETFE) Introduced 1972 Specification numbers F-5</p>	<p>Fails Far 25 Rated temperature 150°C Soft at rated temperature Used as general installation wire but should <u>never</u> be mixed in bundle with other wire types due to softness.</p>	<p>Installed in Arcturus Tefzel was found in Swiss Air flight SR111's In-flight Entertainment System (IFEN) which was suspected as being the cause of the in-flight fire and subsequent crash of the aircraft off Nova Scotia in November 1998.</p>
<p>Cross Linked Tefzel (XL-ETFE) Introduced 1977 Specification numbers MIL-W-22759/34 Spec 55 BMS 13-48 (Boeing)</p>	<p>Fails Far 25 Thickness: 10 microns Weight: 5.0 lbs/1000' (light weight) Rated temperature: 150°C Wet arc tracks Flammable producing copious amount of Dense toxic smoke (96%+ density) when it burns rendering it virtually impossible for flight crew to see their flight instruments. NASA states will fail flammability requirements in 30% oxygen Toxicity - the worst of all wires,</p>	<p>Installed in B747 (currently) B757 (currently) B767 (currently) B777 (currently) Airbus A320 Airbus A330 Airbus A340 <input type="checkbox"/> Still used by BOEING in B747, B757, B767, B777 and Airbus</p>

	<p>banned for manned aerospace use by major manufacturer. (Grumman Corp. banned it in 1982 and NASA followed suit in 1983 due to its toxicity)</p> <p>Soft at rated temperature</p> <p>Loses mechanical strength properties at rated temperature</p> <p>Fails FAR 25 (airworthiness standards test)</p> <p>Projected life 50,000 hrs</p> <p><u>Notch propagation</u> problems</p> <p>A Dangerous Wire</p>	
<p>TKT (Teflon/Kapton/Teflon) Introduced 1992 Specification No: MIL-W-22759 BMS 13-60 (Boeing)</p>	<p>Passes FAR 25</p> <p>Weight: 5.0 lbs. per 1,000 ft (Light weight)</p> <p>Arc-track resistant</p> <p>Abrasion resistant</p> <p>Superb insulation protection</p> <p>High heat tolerance</p> <p>Resists smoking when burning (less than 2% density)</p> <p>Displays all the positive aspects of Kapton (i.e. lightweight, resistance to burning, no fumes when burning etc) without any of Kapton's negatives.</p> <p>No Known Problems</p>	<p>Installed in</p> <p>B737s built after 1992</p> <p>B757s built after 1992</p>

Sources:

Edward Block (IASA)

Michael Murphy

Patrick Price (deceased)

NOTES

☐ Only TKT wire has no known problems and meets FAR 25 requirements.

☐ No specific standards spelt out by aircraft regulatory authorities such as US FAA or European JAR regarding aircraft electrical wire. Specifically no standards defined or any requirement to test wire for:

- Propensity of wire to wet or dry arc track
- Propensity of wire to burn
- The density of smoke and toxicity of fumes when wire burns

☐ Modern jet transport aircraft are required by law (FAA 25 & JAR 25) to ensure all safety of flight items and aircraft systems have adequate backup systems installed in the event of a failure of the main system, (and that includes aircraft electrical systems), yet no thought was given to the failure of the aircraft wiring system itself.

☐ Wire is deemed by most in the aviation industry (i.e. aircraft manufacturers, pilots, airline management and regulatory authorities) as an "install and forget" item. This attitude is best summed up by the comment of United States Federal Aviation Authority (FAA) deputy head, Tom McSweeney, who said on -- in -- "Wire is wire". This attitude ignores the fact that:

- Modern jet transport aircraft contain literally hundreds of kilometers of wire.
- Wire is often damaged during manufacture and/or installation.
- Wire is often incorrectly installed in aircraft. (i.e. incorrectly routed near hot equipment and/or bundled together with other incompatible wire types such as soft wire laying adjacent hard wire etc)
- Wire (both the wire and its insulation) deteriorates with age. With regard to the insulation, it dries out, becomes brittle forming cracks exposing the conductor (i.e. wire) . Wire itself, oxidizes especially associated with the widespread electrolysis that occurs in aircraft leading to poor contacts and the generation of local hot spots in the wire which has the potential to melt the surrounding insulation material.

All wire deteriorates in service due to environmental factors such as:

- extremes of heat & cold experienced by aircraft on the ground and in the air. (i.e. wire can experience plus +200šC down to minus -70šC),
- water damage, ([hydrolysis](#) and the fact that some wire types exhibit [hygroscopic](#) tendencies)
- salt damage associated with marine environments. (all aircraft operate into airfields adjacent marine environments at least some time in their lives)
- contamination by aircraft fluids such as fuel, oil, hydraulic fluid, deicing fluid, cleaning chemicals, toilet residue, galley spillage etc.
- in-flight vibration causing chafing of wires rubbing against other wires or the structure of the aircraft. This is especially a problem with hard wire such as Kapton laying adjacent a soft wire like Tefzel.

- All wire products display differing properties with regard to aging, but practically all wire insulation material dries out, goes hard and then develops hairline fractures which allow the ingress of water and other aviation fluids leading to micro-discharges of current through the cracks to surrounding wires or the aircraft structure. ([ticking](#) faults)
- All aircraft use their airframe as their electrical earth return pathway resulting in significant constraints in the operation of protection devices such as circuit breakers located in the cockpit. (see separate paper on this issue)

 **FAR 25** states: "that insulation material can not be used that is hazardous, unreliable, or contributes smoke/fire."

COMMENT by Ed Block: "No particular uses of insulation were further specified so insulation material includes; seat insulation, insulation blankets, rug insulation, acoustic and wire insulation. They are all types of insulation materials. Unless they are tested with an electrical fire (2,000 degrees) igniter to prove flammability proof, the material can not meet FAR 25 requirements. By their own (limited) standards, the FAA has said, in fact, that most types of wire cannot be used!"

"Only TKT wire insulation (BMS 13-60) meets FAR 25 Standards."

VITA

SUSAN J. KIPTINNESS

Personal Data: Date of Birth: December 6, 1975
Place of Birth: Nairobi, Kenya
Marital Status: Single

Education: Moody Aviation, Elizabethton, Tennessee;
Aviation Technology, B.S., 2000
East Tennessee State University, Johnson City, Tennessee;
Engineering Technology, M.S., 2004

Professional

Experience: Avionics Technician, Avionics America; Knoxville,
Tennessee, 2000-2001
Avionics Technician, Averitt Aviation; Sparta,
Tennessee, 2001-2002
Graduate Assistant, East Tennessee State University,
Department of Technology, 2002-2004